

Distributed by:



www.Jameco.com ♦ 1-800-831-4242

The content and copyrights of the attached material are the property of its owner.

SOLID-STATE HEXADECIMAL DISPLAY WITH INTEGRAL TTL CIRCUIT TO ACCEPT, STORE, AND DISPLAY 4-BIT BINARY DATA

- 0.300-Inch (7,62-mm) Character Height
- High Brightness
- Left-and-Right-Hand Decimals
- Separate LED and Logic Power Supplies May Be Used
- Wide Viewing Angle
- Internal TTL MSI Chip With Latch, Decoder, and Driver
- Operates from 5-V Supply
- Constant-Current Drive for Hexadecimal Characters
- Easy System Interface

mechanical data

These assemblies consist of display chips and a TTL MSI chip mounted on a header with a red molded plastic body. Multiple displays may be mounted on 0.450-inch (11,43-mm) centers.

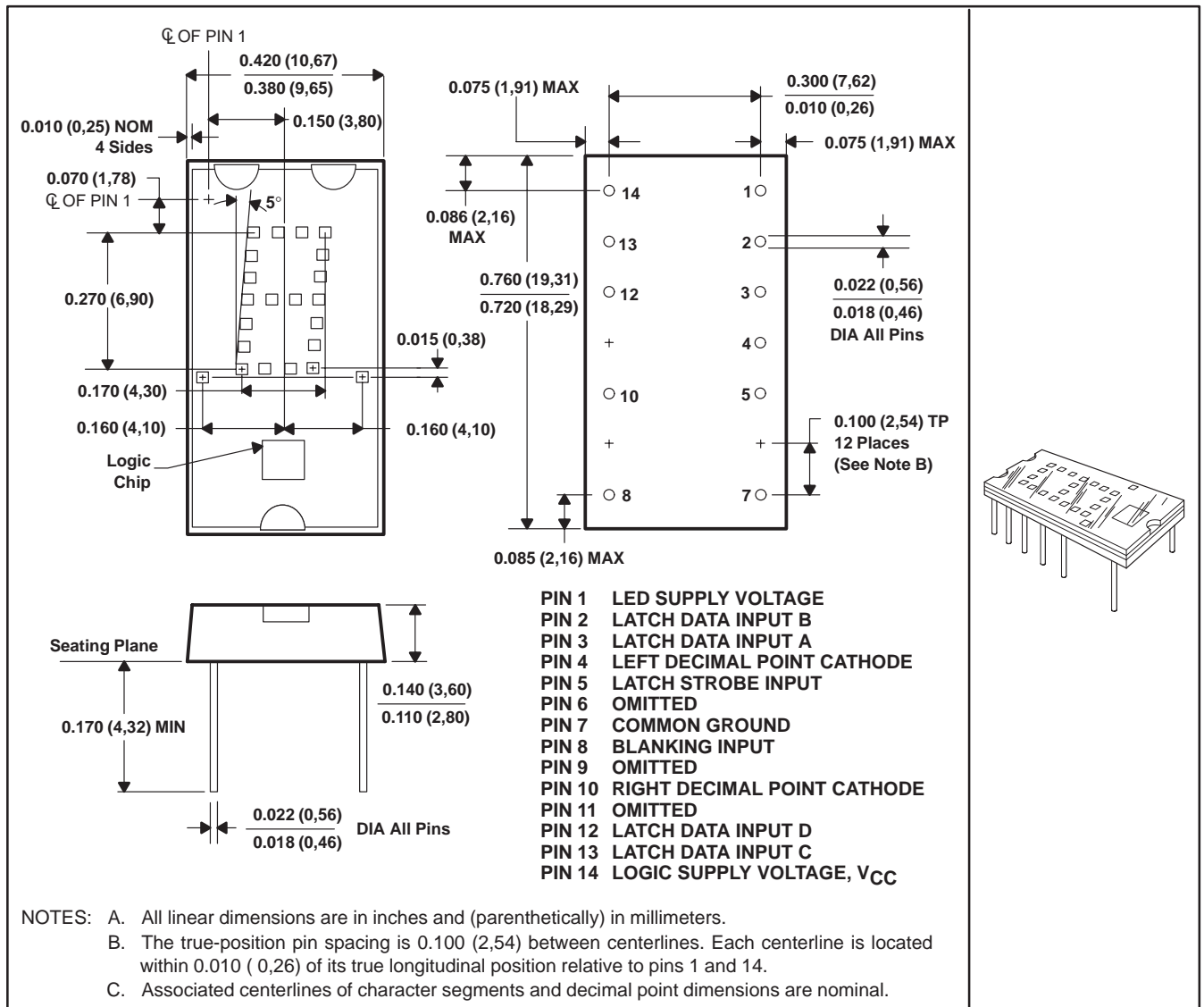

TIL311 HEXADECIMAL DISPLAY WITH LOGIC

SODS001D – MARCH 1972 – REVISED DECEMBER 1997

description

This hexadecimal display contains a four-bit latch, decoder, driver, and 4 × 7 light-emitting-diode (LED) character with two externally driven decimal points in a 14-pin package. A description of the input functions of this device follows.

FUNCTION	PIN NO.	DESCRIPTION
LATCH STROBE INPUT	5	When low, the data in the latches follow the data on the latch data inputs. When high, the data in the latches will not change. If the display is blanked and then restored while the enable input is high, the previous character will again be displayed.
BLANKING INPUT	8	When high, the display is blanked regardless of the levels of the other inputs. When low, a character is displayed as determined by the data in the latches. The blanking input may be pulsed for intensity modulation.
LATCH DATA INPUTS (A, B, C, D)	3, 2, 13, 12	Data on these inputs are entered into the latches when the enable input is low. The binary weights of these inputs are A = 1, B = 2, C = 4, D = 8.
DECIMAL POINT CATHODES	4, 10	These LEDs are not connected to the logic chip. If a decimal point is used, an external resistor or other current-limiting mechanism must be connected in series with it.
LED SUPPLY	1	This connection permits the user to save on regulated V _{CC} current by using a separate LED supply, or it may be externally connected to the logic supply (V _{CC}).
LOGIC SUPPLY VOLTAGE (V _{CC})	14	Separate V _{CC} connection for the logic chip
COMMON GROUND	7	This is the negative terminal for all logic and LED currents except for the decimal points.

The LED driver outputs are designed to maintain a relatively constant on-level current of approximately 5 mA through each LED that forms the hexadecimal character. This current is virtually independent of the LED supply voltage within the recommended operating conditions. Drive current varies slightly with changes in logic supply voltage resulting in a change in luminous intensity as shown in Figure 2. This change will not be noticeable to the eye. The decimal point anodes are connected to the LED supply; the cathodes are connected to external pins. Since there is no current limiting built into the decimal point circuits, limiting must be provided externally if the decimal points are used.

The resultant displays for the values of the binary data in the latches are as shown below.

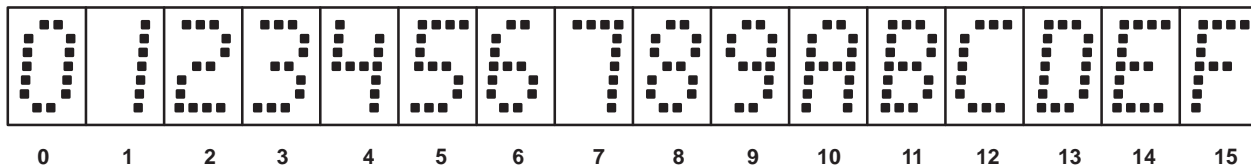

functional block diagram

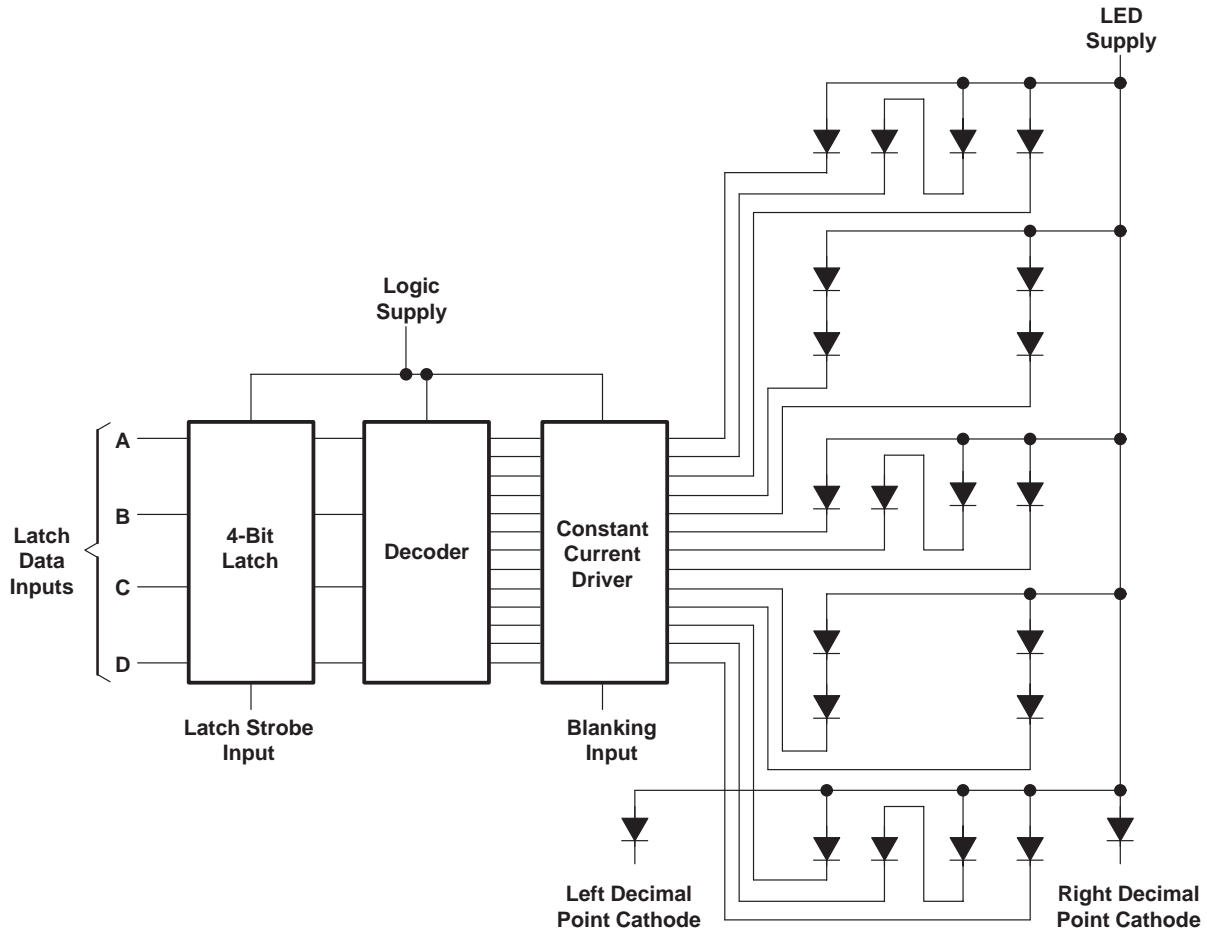

absolute maximum ratings over operating case temperature range (unless otherwise noted)

Supply voltage, V_{CC} , logic (see Note 1)	7 V
Supply voltage, V_{LED} , LED (see Note 1)	7 V
Input voltage (pins 2, 3, 5, 8, 12, 13) (see Note 1)	5.5 V
Decimal point current	20 mA
Operating case temperature range (see Note 2)	0°C to 85°C
Storage temperature range	-25°C to 85°C

- NOTES: 1. Voltage values are with respect to common ground terminal.
 2. Case temperature is the surface temperature of the plastic measured directly over the integrated circuit. Forced-air cooling may be required to maintain this temperature.

recommended operating conditions

	MIN	NOM	MAX	UNIT
Supply voltage, V_{CC} , logic	4.5	5	5.5	V
Supply voltage, V_{LED} , LED	4	5	5.5	V
Decimal point current, $I_{F(DP)}$		5		mA
Pulse duration, t_w , latch strobe	40			ns
Setup time, t_{SU}	50			ns
Hold time, t_H	40			ns



TIL311 HEXADECIMAL DISPLAY WITH LOGIC

SODS001D – MARCH 1972 – REVISED DECEMBER 1997

operating characteristics at $T_A = 25^\circ\text{C}$

PARAMETER		TEST CONDITIONS	MIN	TYP	MAX	UNIT
I_V	Luminous intensity (see Note 3)	Average per character LED $V_{CC} = 5\text{ V}, V_{LED} = 5\text{ V},$ See Note 4	35	100		μcd
		Each decimal $I_F(\text{DP}) = 5\text{ mA}$	35	100		μcd
λ_p	Wavelength at peak emission	$V_{CC} = 5\text{ V}, V_{LED} = 5\text{ V},$ $I_F(\text{DP}) = 5\text{ mA},$ See Note 5		660		nm
$\Delta\lambda$	Spectral bandwidth			20		nm
V_{IH}	High-level input voltage		2			V
V_{IL}	Low-level input voltage				0.8	V
V_{IK}	Input clamp voltage	$V_{CC} = 4.75\text{ V}, I_I = -12\text{ mA}$			-1.5	V
I_I	Input current	$V_{CC} = 5.5\text{ V}, V_I = 5.5\text{ V}$			1	mA
I_{IH}	High-level input current	$V_{CC} = 5.5\text{ V}, V_I = 2.4\text{ V}$			40	μA
I_{IL}	Low-level input current	$V_{CC} = 5.5\text{ V}, V_I = 0.4\text{ V}$			-1.6	mA
I_{CC}	Supply current, logic	$V_{CC} = 5.5\text{ V}, V_{LED} = 5.5\text{ V},$ $I_F(\text{DP}) = 5\text{ mA},$ All inputs at 0 V		60	90	mA
I_{LED}	Supply current, LED			45	90	mA

NOTES: 3. Luminous intensity is measured with a light sensor and filter combination that approximates the CIE (International Commission on Illumination) eye-response curve.

4. This parameter is measured with  displayed, then again with  displayed.

5. These parameters are measured with  displayed.

TYPICAL CHARACTERISTICS

RELATIVE SPECTRAL CHARACTERISTIC

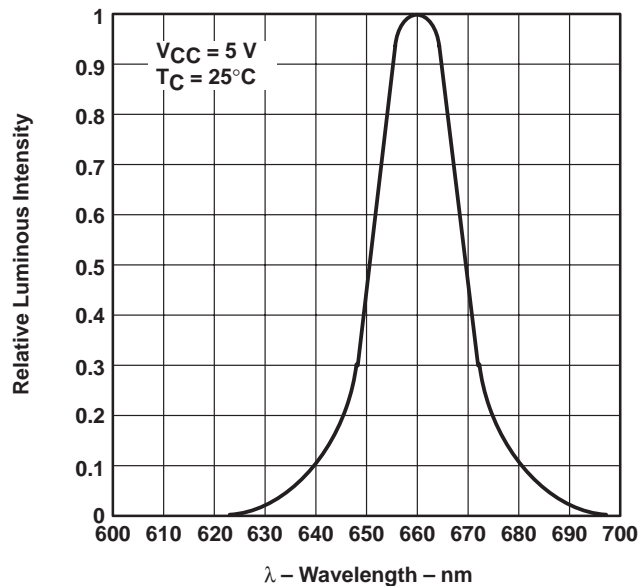

Figure 1



TYPICAL CHARACTERISTICS

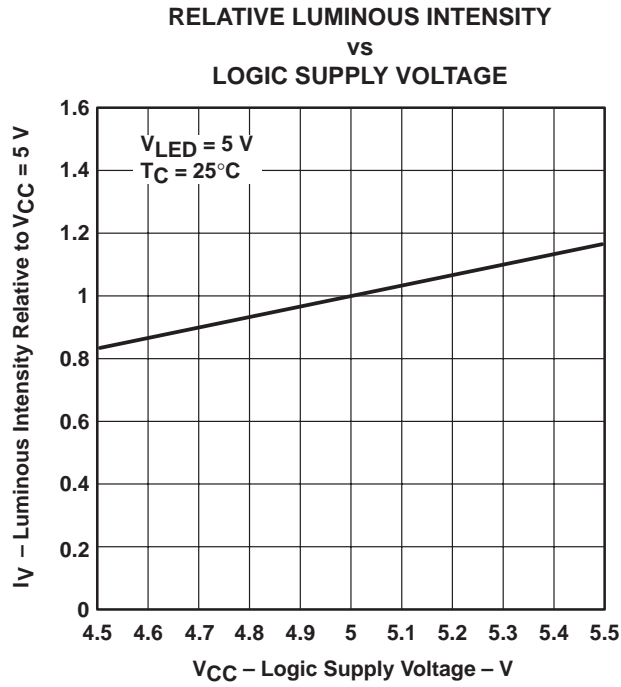

Figure 2

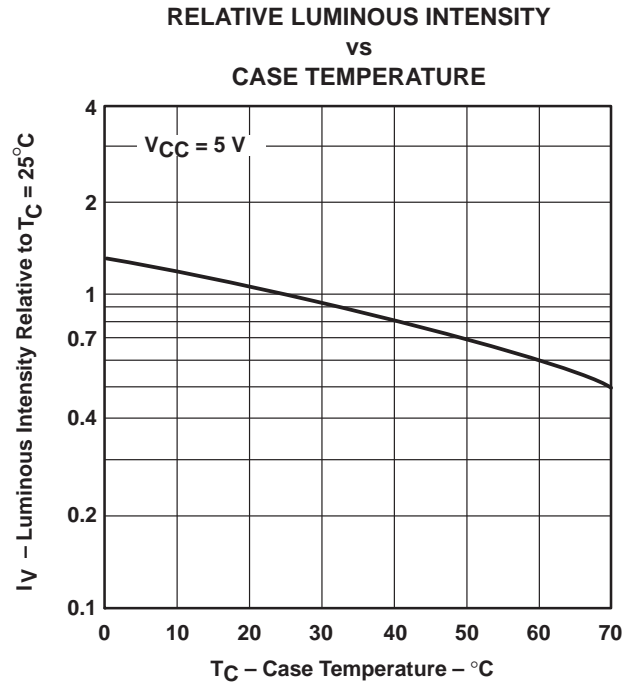

Figure 3

IMPORTANT NOTICE

Texas Instruments and its subsidiaries (TI) reserve the right to make changes to their products or to discontinue any product or service without notice, and advise customers to obtain the latest version of relevant information to verify, before placing orders, that information being relied on is current and complete. All products are sold subject to the terms and conditions of sale supplied at the time of order acknowledgement, including those pertaining to warranty, patent infringement, and limitation of liability.

TI warrants performance of its semiconductor products to the specifications applicable at the time of sale in accordance with TI's standard warranty. Testing and other quality control techniques are utilized to the extent TI deems necessary to support this warranty. Specific testing of all parameters of each device is not necessarily performed, except those mandated by government requirements.

CERTAIN APPLICATIONS USING SEMICONDUCTOR PRODUCTS MAY INVOLVE POTENTIAL RISKS OF DEATH, PERSONAL INJURY, OR SEVERE PROPERTY OR ENVIRONMENTAL DAMAGE ("CRITICAL APPLICATIONS"). TI SEMICONDUCTOR PRODUCTS ARE NOT DESIGNED, AUTHORIZED, OR WARRANTED TO BE SUITABLE FOR USE IN LIFE-SUPPORT DEVICES OR SYSTEMS OR OTHER CRITICAL APPLICATIONS. INCLUSION OF TI PRODUCTS IN SUCH APPLICATIONS IS UNDERSTOOD TO BE FULLY AT THE CUSTOMER'S RISK.

In order to minimize risks associated with the customer's applications, adequate design and operating safeguards must be provided by the customer to minimize inherent or procedural hazards.

TI assumes no liability for applications assistance or customer product design. TI does not warrant or represent that any license, either express or implied, is granted under any patent right, copyright, mask work right, or other intellectual property right of TI covering or relating to any combination, machine, or process in which such semiconductor products or services might be or are used. TI's publication of information regarding any third party's products or services does not constitute TI's approval, warranty or endorsement thereof.