



Vacuum Fluorescent Display Module
Type 3900B series
“General Function”
Software Specification

Model: GU-3900B series

Specification No: DS-1600-0008-00
Date of Issue: October 27, 2010 (00)
Revision:

Published by
NORITAKE ITRON Corp. / Japan
<http://www.noritake-itron.jp>

This specification is subject to change without prior notice.

Contents

- 1 General Description.....4**
 - 1.1 Scope.....4
 - 1.2 Functions.....4
- 2 Operating Mode.....4**
 - 2.1 Normal command mode.....4
 - 2.2 Graphic DMA mode.....4
 - 2.3 User setup mode.....4
 - 2.4 Memory re-write mode.....4
 - 2.5 Test mode.....4
 - 2.6 Power-on setting.....4
- 3 VFD Module model-specific information.....5**
 - 3.1 Timing Unit.....5
 - 3.2 Display Memory configuration.....5
- 4 Normal command mode and User setup mode (Applicable for Parallel and RS-232).....6**
 - 4.1 Displayable image types.....6
 - 4.1.1 Graphic display.....6
 - 4.1.2 Character display.....6
 - 4.2 Memory.....6
 - 4.2.1 Display Memory.....6
 - 4.2.2 Bit image and font definition memory.....7
 - 4.2.3 General-purpose memory.....7
 - 4.3 Cursor.....8
 - 4.4 Window.....9
 - 4.4.1 Base-Window.....9
 - 4.4.2 User-Window.....9
 - 4.5 Write screen mode.....10
 - 4.5.1 Display screen mode.....10
 - 4.5.2 All screen mode.....10
 - 4.6 Protocol.....11
 - 4.6.1 Direct mode.....11
 - 4.6.2 Packet mode.....11
 - 4.7 Commands.....11
 - 4.7.1 Code set.....11
 - 4.7.1.1 Character code.....11
 - 4.7.1.2 Control code.....11
 - 4.7.2 Detail of code set.....12
 - 4.7.2.1 Character display.....12
 - 4.7.2.2 BS (Back Space).....15
 - 4.7.2.3 HT (Horizontal Tab).....15
 - 4.7.2.4 LF (Line Feed).....16
 - 4.7.2.5 HOM (Home Position).....16
 - 4.7.2.6 CR (Carriage Return).....16
 - 4.7.2.7 CLR (Display Clear).....16
 - 4.7.2.8 CAN (Line Clear).....16
 - 4.7.2.9 RCLR (Line end Clear).....16
 - 4.7.3 Command Set.....17
 - 4.7.3.1 General setting commands.....17
 - 4.7.3.2 Character display setting commands.....17
 - 4.7.3.3 Display action setting commands.....18
 - 4.7.3.4 Bit image display setting commands.....19
 - 4.7.3.5 General display setting commands.....21
 - 4.7.3.6 Window display setting commands.....21
 - 4.7.3.7 Download character setting commands.....21
 - 4.7.3.8 User setup mode setting commands.....22
 - 4.7.3.9 General-purpose I/O Port control commands.....22
 - 4.7.3.10 Macro setting commands.....23
 - 4.7.3.11 Other setting commands.....23
 - 4.7.4 Command Set Details.....25
 - 4.7.4.1 US X n (Brightness level setting).....25
 - 4.7.4.2 ESC @ (Initialize Display).....25
 - 4.7.4.3 US \$ x y (Cursor Set).....25
 - 4.7.4.4 US C n (Cursor display ON/OFF).....25
 - 4.7.4.5 US (w 10h a (Write screen mode select).....26
 - 4.7.4.6 ESC R n (International font set).....26
 - 4.7.4.7 ESC t n (Character table type).....27
 - 4.7.4.8 US MD1 (Over-write mode).....27
 - 4.7.4.9 US MD2 (Vertical scroll mode).....27
 - 4.7.4.10 US MD3 (Horizontal scroll mode).....27
 - 4.7.4.11 US MD5 (Horizontal scroll mode, scroll ON).....27
 - 4.7.4.12 US s n (Horizontal scroll speed).....27
 - 4.7.4.13 US (g 01h m (Font size select).....28
 - 4.7.4.14 US (g 02h m (2-byte character).....28
 - 4.7.4.15 US (g 03h m, US (g 0Fh m (2-byte character type).....28
 - 4.7.4.16 US (g 04h m (Font Width).....29
 - 4.7.4.17 US (g 05h n (FROM Extended Font).....30
 - 4.7.4.18 US (g 40h x y (Font Magnification).....30

| | | |
|----------|---|-----------|
| 4.7.4.19 | US (g 41h b (Bold character)..... | 30 |
| 4.7.4.20 | US (a 01h t (Wait)..... | 30 |
| 4.7.4.21 | US (a 02h t (Short Wait)..... | 30 |
| 4.7.4.22 | US (a 10h wL wH cL cH s (Scroll display action)..... | 31 |
| 4.7.4.23 | US (a 11h p t1 t2 c (Blink)..... | 31 |
| 4.7.4.24 | US (a 12h v s p (Curtain display action)..... | 32 |
| 4.7.4.25 | US (a 13h v s pL pH (Spring display action)..... | 32 |
| 4.7.4.26 | US (a 14h s pL pH (Random display action)..... | 33 |
| 4.7.4.27 | US (a 40h p (Display power ON/OFF/auto-OFF)..... | 34 |
| 4.7.4.28 | US (a 40h 11h t (Display power auto-OFF time)..... | 34 |
| 4.7.4.29 | US (d 10h pen xL xH yL yH (Dot drawing)..... | 34 |
| 4.7.4.30 | US (d 11h mode pen x1L x1H y1L y1H x2L x2H y2L y2H (Line/Box pattern drawing)..... | 34 |
| 4.7.4.31 | US (f 20h xPL xPH yPL yPH m aL aH aE ySL ySH xOL xOH yOL yOH xL xH yL yH g) (Dot unit downloaded bit image display)..... | 36 |
| 4.7.4.32 | US (d 21h xPL xPH yPL yPH xL xH yL yH g d(1)...d(k) (Dot unit real-time bit image display)..... | 39 |
| 4.7.4.33 | US (d 30h xPL xPH yPL yPH m bLen d(1)...d(bLen) (Dot unit character display)..... | 41 |
| 4.7.4.34 | US (f 11h xL xH yL yH g d(1)...d(k) (Real-time bit image display)..... | 42 |
| 4.7.4.35 | US (f 01h aL aH aE sL sH sE d(1)...d(s) (RAM bit image definition)..... | 43 |
| 4.7.4.36 | US (e 10h aL aH aE sL sH sE d(1)...d(s) (FROM bit image definition)..... | 44 |
| 4.7.4.37 | US (f 10h m aL aH aE ySL ySH xL xH yL yH g) (Downloaded bit image display)..... | 46 |
| 4.7.4.38 | US (f 90h m aL aH aE ySL ySH xL xH yL yH g s) (Downloaded bit image scroll display)..... | 48 |
| 4.7.4.39 | US m n (Horizontal scroll display quality select)..... | 50 |
| 4.7.4.40 | US r n (Reverse display)..... | 50 |
| 4.7.4.41 | US w n (Write mixture display mode)..... | 50 |
| 4.7.4.42 | US (w 01h a (Window select)..... | 50 |
| 4.7.4.43 | US (w 02h a b[xPL xPH yPL yPH xSL xSH ySL ySH] (User Window define / cancel)..... | 51 |
| 4.7.4.44 | ESC % n (Download character ON/OFF)..... | 52 |
| 4.7.4.45 | ESC & a c1 c2 [x1 d1...d(y×x1)]...[xk d1...d(y×xk)] (Download character definition)..... | 52 |
| 4.7.4.46 | ESC ? a c (Download character delete)..... | 52 |
| 4.7.4.47 | US (g 10h c1 c2 d1...d32 (16×16 Download character definition)..... | 53 |
| 4.7.4.48 | US (g 11h c1 c2 (16×16 Downloaded character delete)..... | 53 |
| 4.7.4.49 | US (g 14h c1 c2 d1...d128 (32×32 Download character definition)..... | 53 |
| 4.7.4.50 | US (g 15h c1 c2 (32×32 Downloaded character delete)..... | 54 |
| 4.7.4.51 | US (e 11h a (Download character save)..... | 54 |
| 4.7.4.52 | US (e 21h a (Download character restore)..... | 54 |
| 4.7.4.53 | US (e 13h m P(80h-1) P(80h-2)...P(FFh-n) (FROM User font definition)..... | 55 |
| 4.7.4.54 | US (e 15h a b p(1)...p(65536) (FROM extension font definition)..... | 55 |
| 4.7.4.55 | US (e 01h d1 d2 (User setup mode start)..... | 55 |
| 4.7.4.56 | US (e 02h d1 d2 d3 (User setup mode end)..... | 55 |
| 4.7.4.57 | US (p 01h n a (I/O Port Input / Output setting)..... | 56 |
| 4.7.4.58 | US (p 10h n a (I/O Port Output)..... | 56 |
| 4.7.4.59 | US (p 20h n (I/O Port Input)..... | 56 |
| 4.7.4.60 | US : pL pH [d1...dk] (RAM Macro define / delete)..... | 57 |
| 4.7.4.61 | US (e 12h a pL pH t1 t2 [d(1)...d(p)] (FROM Macro define / delete)..... | 57 |
| 4.7.4.62 | US ^ n t1 t2 (Macro execution)..... | 58 |
| 4.7.4.63 | US (i 20h a b c (Macro end condition)..... | 59 |
| 4.7.4.64 | US (e 03h a b (Memory SW setting)..... | 59 |
| 4.7.4.65 | US (e 04h a (Memory SW data send)..... | 60 |
| 4.7.4.66 | US (e 18h sL sH sE m1 a1L a1H a1E d[1]...d[s] (General-purpose memory store)..... | 60 |
| 4.7.4.67 | US (e 19h sL sH sE m1 a1L a1H a1E m2 a2L a2H a2E (General-purpose memory transfer)..... | 61 |
| 4.7.4.68 | US (e 28h sL sH sE m1 a1L a1H a1E (General-purpose memory send)..... | 61 |
| 4.7.4.69 | US (e 40h a [b c] (Display status send)..... | 62 |
| 4.7.4.70 | US (i 10h a b (RS-232 serial settings)..... | 62 |
| 4.7.4.71 | FS M m d1...d6 (Memory re-write mode)..... | 62 |
| 4.8 | Bit image data format..... | 63 |
| 4.9 | Download character format..... | 63 |
| 5 | Graphic DMA mode (Applicable for Parallel interface only)..... | 64 |
| 5.1 | Displayable image types..... | 64 |
| 5.1.1 | Graphic display..... | 64 |
| 5.2 | Display Memory..... | 64 |
| 5.3 | Protocol..... | 64 |
| 5.4 | Commands..... | 65 |
| 5.4.1 | Command Details..... | 65 |
| 5.4.1.1 | STX 44h DAD 46h aL aH sL sH d(1)...d(s) (Bit image write)..... | 65 |
| 5.4.1.2 | STX 44h DAD 42h aL aH sXL sXH sYL sYH d(1)...d(s) (BOX Area Bit image write)..... | 66 |
| 5.4.1.3 | STX 44h DAD 53h aL aH (Display start address)..... | 67 |
| 5.4.1.4 | STX 44h DAD 57h 01h (Display synchronous)..... | 67 |
| 5.4.1.5 | STX 44h DAD 58h n (Brightness level)..... | 67 |
| 6 | Setup..... | 68 |
| 6.1 | DIP-Switch (SW1)..... | 68 |
| 6.1.1 | Display address (for Packet mode and Graphic DMA mode)..... | 68 |
| 6.1.2 | RS-232 communication settings..... | 68 |
| 6.1.3 | Command Mode..... | 68 |
| 6.1.4 | Operating Mode..... | 69 |
| 6.1.5 | Protocol mode..... | 69 |
| 6.2 | Memory SW..... | 69 |
| | Notice for the Cautious Handling of VFD Modules..... | 70 |
| | Revision history..... | 71 |

1 General Description

1.1 Scope

This specification covers the software aspects of the GU-3900B series vacuum fluorescent graphic display modules.

Related specifications: Hardware specification for specific GU-3900B VFD module.
 Program Macro specification: (Refer to 4.7.4.60 RAM Macro define / delete)
 (Refer to 4.7.4.61 FROM Macro define / delete)
 Character fonts specification: (Refer to 4.7.2.1 Character display)

1.2 Functions

Character display, Graphic display, Control command, Display action command, Download (user-definable) font, User-definable font table function, Draw command, Window function, General-purpose I/O port control, Macro, Program Macro function, Bit Image download function, Memory SW, Data storage.

2 Operating Mode

The operating modes are as follows, selected by DIP-SW, TEST terminal, or software command.

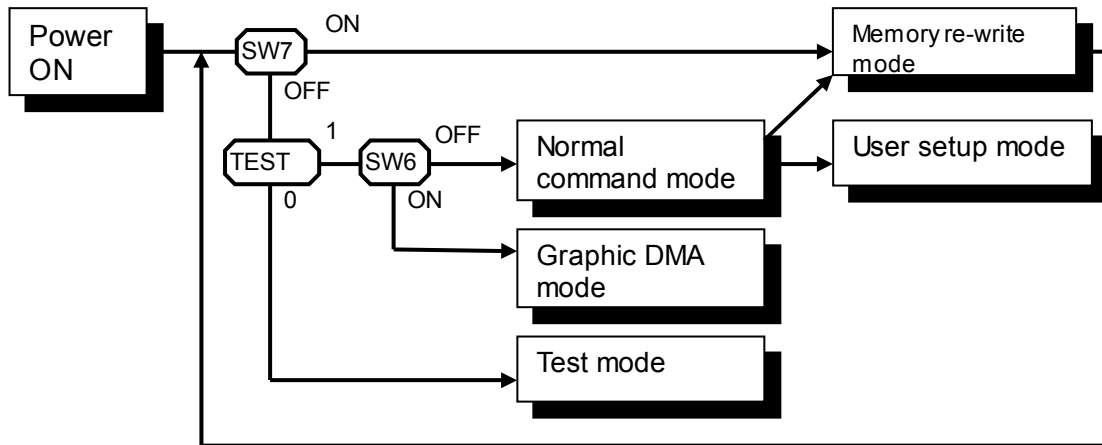

2.1 Normal command mode

Normal operation mode in which the module can receive commands and data via the various interfaces. There are two types of protocol for commands and data, selected by DIP-SW.

2.2 Graphic DMA mode

Normal operation mode in which the module can receive graphic data and commands via the parallel interface with high-speed data writing. High-speed graphic display is possible using this mode.

2.3 User setup mode

This mode is used for saving Memory-SW and various data to FROM.

2.4 Memory re-write mode

Mode for re-writing firmware and built-in font data. Do not use unless necessary.

2.5 Test mode

Test for display and internal operation. Used for factory test.

2.6 Power-on setting

At power-on, the various display settings are set to default value, or value stored in Memory SW (refer to 6.2 Memory SW).

If "Restore at power-on" is enabled, the various content in FROM is transferred to RAM before starting standard operation.

If "Macro execution at power-on" is enabled, Macro or Program Macro is automatically executed.

3 VFD Module model-specific information

3.1 Timing Unit

Timing unit length varies between different modules. The timing unit length for each module display dot size is shown below.

| Module | Timing unit (Typ.) ± 5% |
|---------|-------------------------|
| 128X128 | 14ms |
| 256X16 | 14ms |
| 256X32 | 14ms |
| 256X64 | 14ms |
| 256X128 | 15ms |
| 320X32 | 14ms |
| 384X32 | 13ms |
| 512X32 | 14ms |

Timing unit affects the timing of the following commands and operations:

4.7.4.12 US s n (Horizontal scroll speed)

4.7.4.21 US (a 02h t (Short Wait)

4.7.4.23 US (a 11h p t1 t2 c (Blink)

4.7.4.24 US (a 12h v s p (Curtain display action)

4.7.4.25 US (a 13h v s pL pH (Spring display action)

4.7.4.26 US (a 14h s pL pH (Random display action)

4.7.4.38 US (f 90h m aL aH aE ySL ySH xL xH yL yH g s) (Downloaded bit image scroll display)

4.7.4.61 US (e 12h a pL pH t1 t2 [d(1)...d(p)] (FROM Macro define / delete)

4.7.4.62 US ^ n t1 t2 (Macro execution)

3.2 Display Memory configuration

Display Memory size and configuration varies between different modules. The configuration for each module display dot size is shown below. For each module, the following eight module-specific values, referred to throughout this specification, are also stated:

Xdots: The number of dots in the X-direction (horizontal) for the entire Display Memory.

Ydots: The number of dots in the Y-direction (vertical) for the entire Display Memory.

Ybytes: Ydots÷8. Used when specifying Y-parameter in bytes (8-dot units).

Max_Xdot: Xdots-1. Valid X-coordinate values range from 0 to Max_Xdot.

Max_Ydot: Ydots-1. Valid Y-coordinate values range from 0 to Max_Ydot.

Max_Ybyte: Ybytes-1. Valid Y-coordinate 8-dot unit values range from 0 to Max_Ydot.

DispMemSize: Size of Display Memory in bytes.

Max_DispmemAddr: DispMemSize-1. Valid Display Memory addresses range from 0 to Max_DispmemAddr.

Refer also to 4.2.1 Display Memory.

| Display area (Module size) | Hidden area | Total area | Display Memory | | | | | | | |
|-------------------------------|-------------|------------|----------------|-------|--------|----------|----------|-----------|-----------------|-------------|
| | | | Xdots | Ydots | Ybytes | Max_Xdot | Max_Ydot | Max_Ybyte | Max_DispmemAddr | DispMemSize |
| 128×128 | 128×128 | 256×128 | 100h | 80h | 10h | 0FFh | 7Fh | 0Fh | 0FFFh | 1000h |
| 256×16 | 1792×16 | 2048×16 | 800h | 10h | 02h | 7FFh | 0Fh | 01h | 0FFFh | 1000h |
| 256×32 | 768×32 | 1024×32 | 400h | 20h | 04h | 3FFh | 1Fh | 03h | 0FFFh | 1000h |
| 256×64 | 256×64 | 512×64 | 200h | 40h | 08h | 1FFh | 3Fh | 07h | 0FFFh | 1000h |
| 256×128 | 256×128 | 512×128 | 200h | 80h | 10h | 1FFh | 7Fh | 0Fh | 1FFFh | 2000h |
| 320×32 | 704×32 | 1024×32 | 400h | 20h | 04h | 3FFh | 1Fh | 03h | 0FFFh | 1000h |
| 384×32 | 640×32 | 1024×32 | 400h | 20h | 04h | 3FFh | 1Fh | 03h | 0FFFh | 1000h |
| 512×32 | 512×32 | 1024×32 | 400h | 20h | 04h | 3FFh | 1Fh | 03h | 0FFFh | 1000h |

4 Normal command mode and User setup mode (Applicable for Parallel and RS-232)

4.1 Displayable image types

4.1.1 Graphic display

Number of dots: Depends on VFD module.
(Refer to 3 VFD Module model-specific information)

4.1.2 Character display

Character mode: **1-byte character:** 6×8 dot, 8×16 dot, 12×24 dot, 16×32 dot mode
2-byte character: 16×16 dot, 32×32 dot mode

Built-in Character font type: **1-byte character:** 6×8 dot, 8×16 dot, 12×24 dot, 16×32 dot
– ANK, International font (specification DS-1600-0004-XX)
2-byte character:
16×16 dot
– Japanese Kanji (specification DS-906-0002-XX)
– Simplified Chinese (specification DS-954-0006-XX)
– Traditional Chinese (specification DS-954-0007-XX)
– Korean (specification DS-954-0008-XX)
32×32 dot
– Japanese Kanji (specification DS-906-0003-XX)

Standard fonts:

| Font size | 1-byte character | 2-byte character | | | |
|-----------|------------------|------------------|----------|--------------------|---------------------|
| | International | Japanese | Korean | Simplified Chinese | Traditional Chinese |
| 6×8 | ○ | × | × | × | × |
| 8×16 | ○ | ○(16×16) | ○(16×16) | ○(16×16) | ○(16×16) |
| 12×24 | ○ | × | × | × | × |
| 16×32 | ○ | ○(32×32) | × | × | × |

4.2 Memory

4.2.1 Display Memory

Display Memory is comprised of Display area and Hidden area (refer to 3.2 Display Memory configuration).

By using "User Window" function, the memory area can be separated, and each separate window can be controlled independently (refer to 4.7.4.43 User Window define / cancel).

Hidden area can be displayed by using scroll or other action commands.

Example: Display Memory configuration for 256×64 dot module.

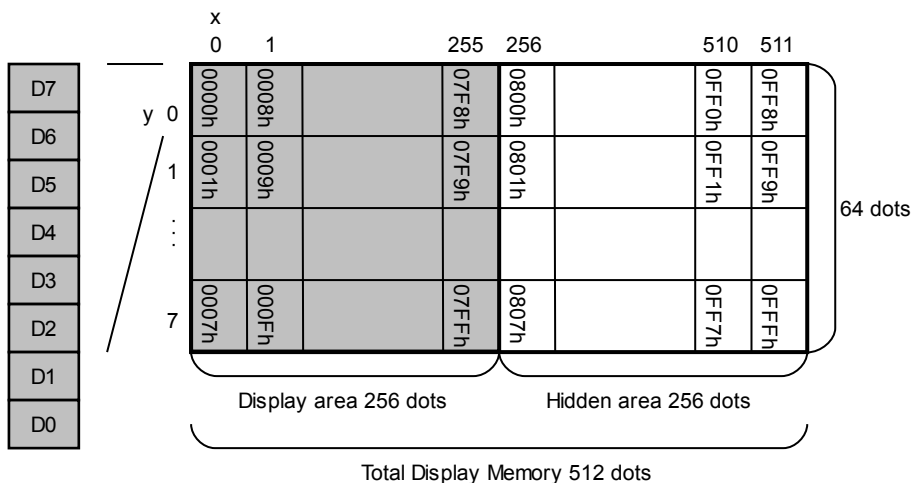

4.2.2 Bit image and font definition memory

Bit image definition

Arbitrary bit image data can be defined and saved using bit image definition commands.

RAM: 4096 bytes

FROM: 32768 bytes + Extension area 262144 bytes

(Refer to 4.7.4.35 RAM bit image definition and 4.7.4.36 FROM bit image definition)

User-defined fonts

Memory for arbitrary user-defined fonts is available as follows.

Download character

For each of the font sizes 6×8, 8×16, 12×24, and 16×32 dot (1-byte character), and 16×16 and 32×32 dot (2-byte character), a maximum of 16 characters can be defined to memory space in RAM.

FROM user font

For each of the font sizes 6×8, 8×16, 12×24, and 16×32 dot (1-byte character), a maximum of 128 characters can be defined to memory space in FROM.

FROM extension font

For each of the font sizes 6×8, 8×16, 12×24, and 16×32 dot (1-byte character), an arbitrary font can be defined to memory space in FROM.

Refer to 4.7.4.45 Download character definition, 4.7.4.47 16×16 dot download character definition, 4.7.4.49 32×32 dot download character definition, 4.7.4.53 FROM User Font definition, 4.7.4.54 FROM extension font definition.

User-defined fonts summary:

| Font size | 1-byte character | | | 2-byte character |
|----------------|--------------------|----------------|---------------------|--------------------|
| | Download character | FROM user font | FROM extension font | Download character |
| 6×8 dot mode | ○ | ○ | ○ | × |
| 8×16 dot mode | ○ | ○ | ○ | ○(16×16) |
| 12×24 dot mode | ○ | ○ | ○ | × |
| 16×32 dot mode | ○ | ○ | ○ | ○(32×32) |

4.2.3 General-purpose memory

Arbitrary data can be stored to and retrieved from the memory.

General-purpose RAM: 1024 bytes

General-purpose FROM: 4096 bytes × 16 areas

General-purpose RAM

| |
|------------------|
| 000000h – 003FFh |
|------------------|

General-purpose FROM

| |
|-------------------|
| 000000h – 000FFFh |
| 001000h – 001FFFh |
| 002000h – 002FFFh |
| ... |
| 00F000h – 00FFFFh |

Note: Operation which exceeds a FROM area is not possible.

4.3 Cursor

Cursor indicates the write start position for displaying a character or bit image.

Cursor consists of 1 dot horizontally and 8 dots vertically.

Character and Bit image is written to the right in the X direction and downwards in the Y direction from and including the Cursor position.

Cursor position can be moved by "Cursor set" command (refer to 4.7.4.3 Cursor set).

The cursor is normally not displayed, but can be displayed by 4.7.4.4 Cursor display ON/OFF command.

Cursor position relates to Display Memory as shown below.

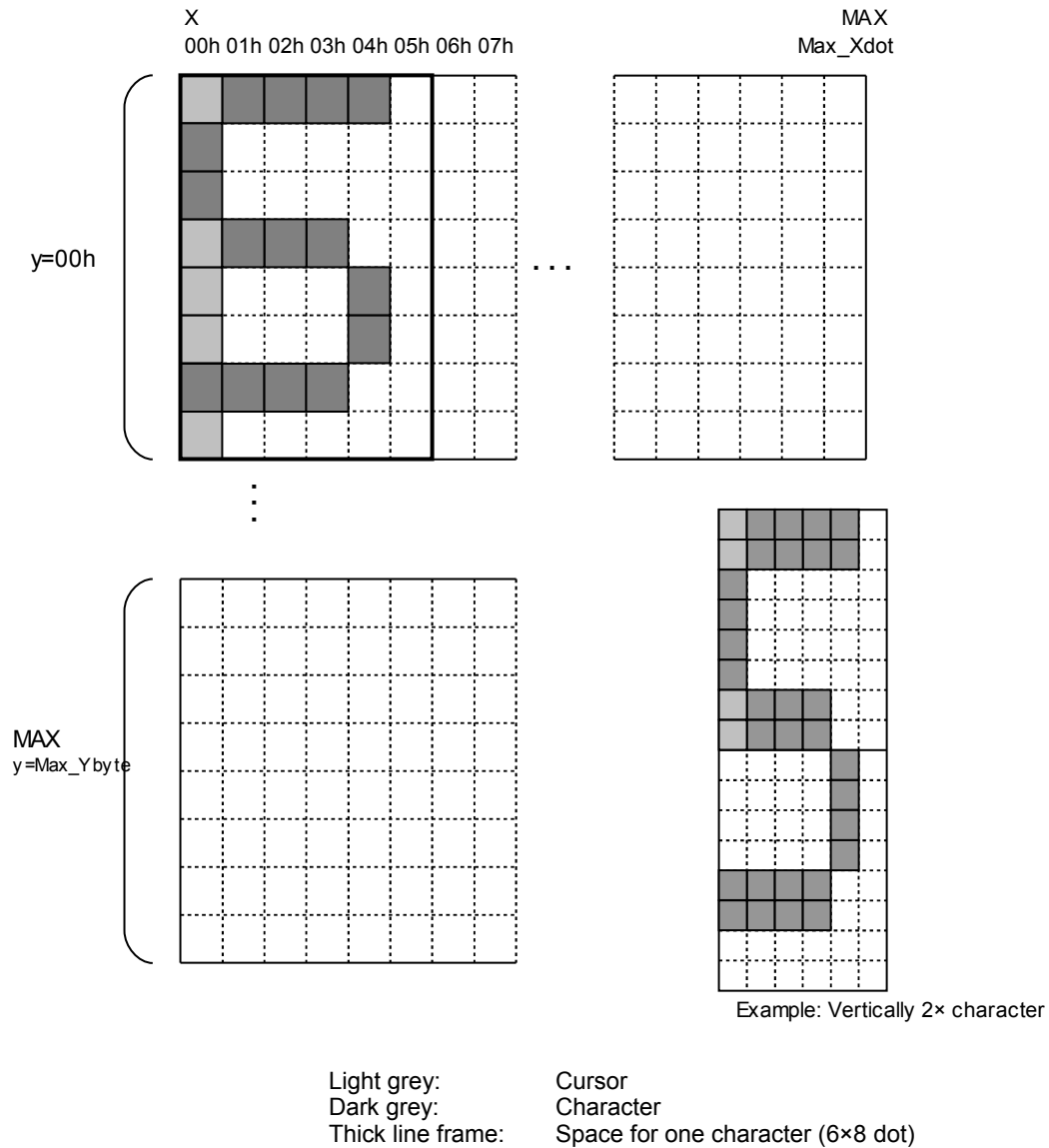

4.4 Window

Window function enables the display screen to be divided into "windows" each of which can be controlled and displayed independently.

Display Memory is shared by all windows; individual windows do not have their own display memory. There are 2 types of "window": Base-Window and User-Window.

Refer to 4.7.4.43 User Window define / cancel.

4.4.1 Base-Window

Base-Window covers the entire display screen. If no User-Windows are defined, all display operation is processed on this window. If one or more User-Windows are defined, display operation on any area not covered by a User-Window is done by selecting Base-Window. When Base-Window is selected, even if User-Window(s) are defined, all display operation is processed under Base-Window. Therefore the current display contents of User-Window(s) is overwritten.

Operation on Base-Window depends on the setting of "Write screen mode" (refer to 4.5 Write screen mode).

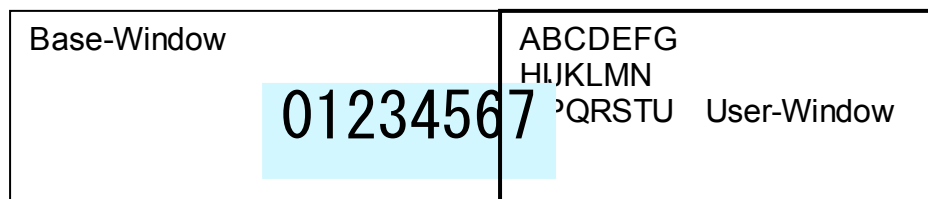

4.4.2 User-Window

User-Window is defined by User-Window definition command. Display operation is processed on the window selected by Current Window select command.

A maximum of 4 User-Windows can be defined.

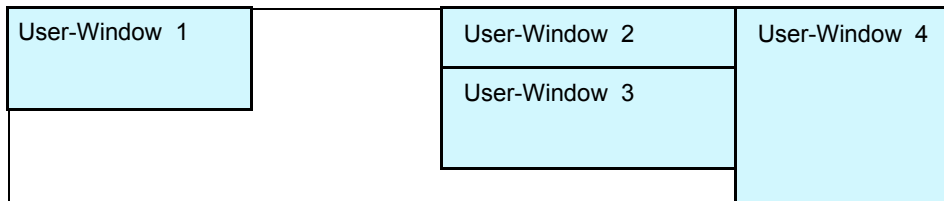

4.5 Write screen mode

This setting is only applicable for Base-Window.

There are two Write screen modes, Display screen mode and All screen mode. The mode is set by command (refer to 4.7.4.5 Write screen mode select).

4.5.1 Display screen mode

When the cursor is located in the Display area, all operation will be done within Display area, and when cursor is located in the Hidden area, it will be done within Hidden area.

Character write depends on the specified character display mode.

Bit image is written within the current area, and any data outside the area is ignored.

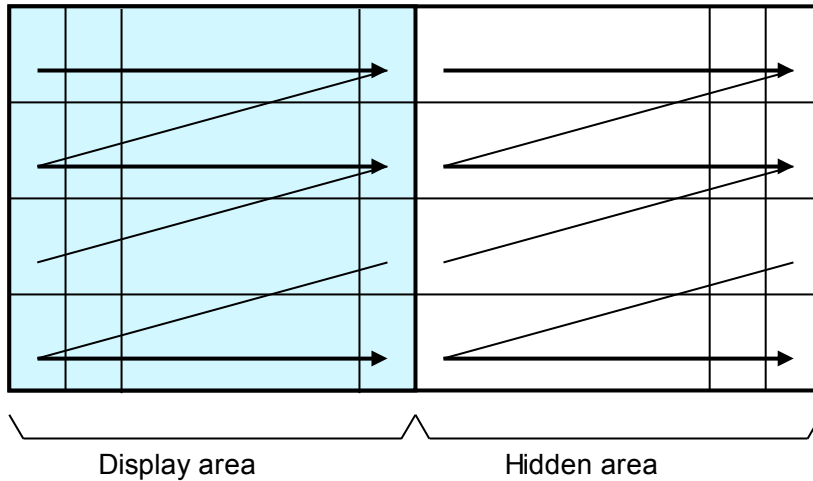

4.5.2 All screen mode

Regardless of the cursor position, operation will be done over the entire area.

Character write depends on the specified character display mode.

Bit image is written within the entire memory area, and any data outside the area is ignored.

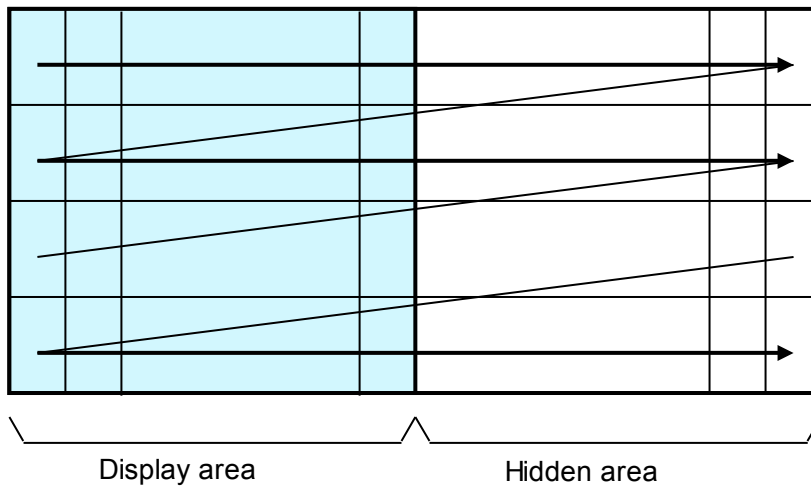

4.6 Protocol

One of two protocols is selected by DIP-SW.

4.6.1 Direct mode

The module processes all received data; the display address setting is ignored.

Direct mode is applicable for all interfaces.

4.6.2 Packet mode

The module only processes data in packets with an address that matches the display's address set by DIP-SW + MSW.

Using this mode, a maximum of 255 displays can be controlled individually.

Data in packets addressed to FFh is processed by all connected displays.

Packet mode is applicable for Parallel and RS-232 serial interface.

| Header | Address | Data length | Data | Footer | BCC |
|-----------|---------|-------------|---------------|-----------|---------|
| STX (02h) | 00h–FFh | 01h–80h | 00h–FFh | ETX (03h) | 00h–FFh |
| 1 byte | 1 byte | 1 byte | 1–128 byte(s) | 1 byte | 1 byte |

BCC: XOR value from Header to Footer inclusive.

Packet response can be sent, depending on MSW setting.

If packet address and display address matches, and packet is correctly received, ACK reply is sent from display.

For packets addressed to FFh, only the display with address 00h sends a response.

If a BCC or other error occurs, no response is sent.

The packet response is sent with priority, which may corrupt any data remaining in the display's transmit buffer, so the host should wait until all data has been received before sending the next packet.

| |
|-----------|
| Response |
| ACK (06h) |
| 1 byte |

4.7 Commands

This section describes the operation of each command.

Within these explanations, Character (x-dot) and Line (y-dot) refer to the number of dots determined by the "Font size select" and "Font magnification" settings, etc.

For commands that produce response data from the display, this data is placed in the send buffer, then transmitted. When DSR=MARK (BUSY), data transmission is halted, and during any time when there is no space in the send buffer, command processing is halted. Caution is needed when using these commands via the parallel interface.

4.7.1 Code set

4.7.1.1 Character code

| Command Name | Hex Code | Operation | Page |
|-------------------|---------------------------------------|---|------|
| Character display | 20h – FFh or 2-byte character code | Display character at the current cursor position. | p12 |

4.7.1.2 Control code

| Command Name | Hex Code | Operation | Page |
|---------------------|----------|--|------|
| BS Back Space | 08h | Cursor moves left by one character. | p15 |
| HT Horizontal Tab | 09h | Cursor moves right by one character. | p15 |
| LF Line Feed | 0Ah | Cursor moves down by one line. | p16 |
| HOM Home Position | 0Bh | Cursor moves to home position (top left). | p16 |
| CR Carriage Return | 0Dh | Cursor moves to left end of the current line. | p16 |
| CLR Display Clear | 0Ch | Display screen is cleared, cursor moves to home position. | p16 |
| CAN Line clear | 18h | Current line is cleared and cursor moves to left end. | p16 |
| RCLR Line end clear | 19h | Current line is cleared from cursor position to right end. | p16 |

4.7.2 Detail of code set

4.7.2.1 Character display

Code: 20h – FFh or 2-byte character code

Function: Display character at cursor position.

Font size can be selected, 6×8, 8×16, 12×24, or 16×32 (refer to 4.7.4.13 "Font size select").

To display a 2-byte character, the following settings are required:

Font size select = 8×16 dot or 16×32 dot, (m=02h or 04h)

2-byte character = ON (m=01h)

2-byte character type = Japanese, Korean, Simplified or Traditional Chinese

Refer to 4.7.4.14 "2-byte character", and 4.7.4.15 "2-byte character type" for details.

The 2-byte character code depends on the type of built-in character fonts. This module has the following built-in 2-byte character fonts.

| Font type | Code type | First byte | Second byte |
|---------------------|-----------------------|-----------------------------------|-----------------------------------|
| Japanese | JIS X0208 (Shift-JIS) | 81h ≤ c1 ≤ 9Fh, E0h ≤ c1 ≤ EFh | 40h ≤ c2 ≤ 7Eh, 80h ≤ c2 ≤ FCh |
| Korean | KSC5601-87 | A1h ≤ c1 ≤ FEh | A1h ≤ c2 ≤ FEh |
| Simplified Chinese | GB2312-80 | A1h ≤ c1 ≤ FEh | A1h ≤ c2 ≤ FEh |
| Traditional Chinese | Big-5 | A1h ≤ c1 ≤ FEh | 40h ≤ c2 ≤ 7Eh, A1h ≤ c2 ≤ FEh |

This command operates on the currently-selected window (refer to Current window select).

Regardless of the cursor position, if the character size (x and/or y) exceeds the window size, the command is ignored.

Details of operation are as follows:

MD1 (Over-write mode)

| Cursor position | | Figure Number | Operation |
|---------------------------------------|--|---------------|--|
| X direction | Y direction | | |
| Space for character on right side. | Space for character at current cursor position. | ① | Display character at cursor. Horizontal Tab (HT). |
| | No space for character at current cursor position. | ② | Cursor moves to the left end of top line (OP3). Display character at cursor. Horizontal Tab (HT). |
| No space for character on right side. | Space for character in next lower line. | ③ | Display space at cursor (OP1). Cursor moves to left end of next lower line (OP4). Display character at cursor. Horizontal Tab (HT). |
| | No space for character in next lower line. | ④ | Display space at cursor (OP1). Cursor moves to left end of top line (OP2). Display character at cursor. Horizontal Tab (HT). |
| | No space for character at current cursor position. | ⑤ | Cursor moves to the left end of top line (OP2). Display character at cursor. Horizontal Tab (HT). |

Note: HT operation depends on cursor position (refer to 4.7.2.3 Horizontal Tab).

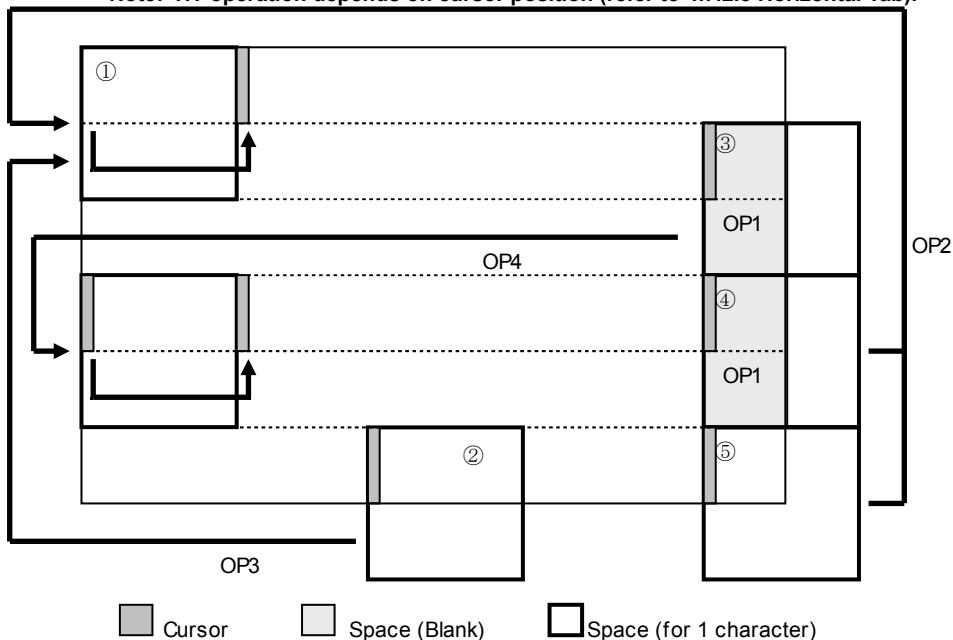

MD2 (Vertical scroll mode)

| Cursor position | | Figure Number | Display Operation |
|---------------------------------------|--|---------------|---|
| X direction | Y direction | | |
| Space for character on right side. | Space for character at current cursor position. | ① | Display character at cursor. Horizontal Tab (HT) (OP4). |
| | No space for character at current cursor position. | ② | Display contents are scrolled up the required number of dots, and the bottom line is cleared. Cursor moves to the displayable upper position (OP3). Display character at cursor Horizontal Tab (HT) |
| No space for character on right side. | Space for character in next lower line. | ③ | Display space at cursor (OP1). Cursor moves to the left end of next lower line (OP2). Display character at cursor. Horizontal Tab (HT). |
| | No space for character in next lower line. | ④ | Display space at cursor (OP1). Display contents are scrolled up the required number of dots, and the bottom line is cleared. Cursor moves to left end of bottom line (OP5). Display character at cursor. Horizontal Tab (HT). |
| | No space for character at current cursor position. | ⑤ | Display contents are scrolled up the required number of dots, and the bottom line is cleared. Cursor moves to left end of bottom line (OP5) Display character at cursor. Horizontal Tab (HT). |

Note: HT operation depends on cursor position (refer to 4.7.2.3 Horizontal Tab).

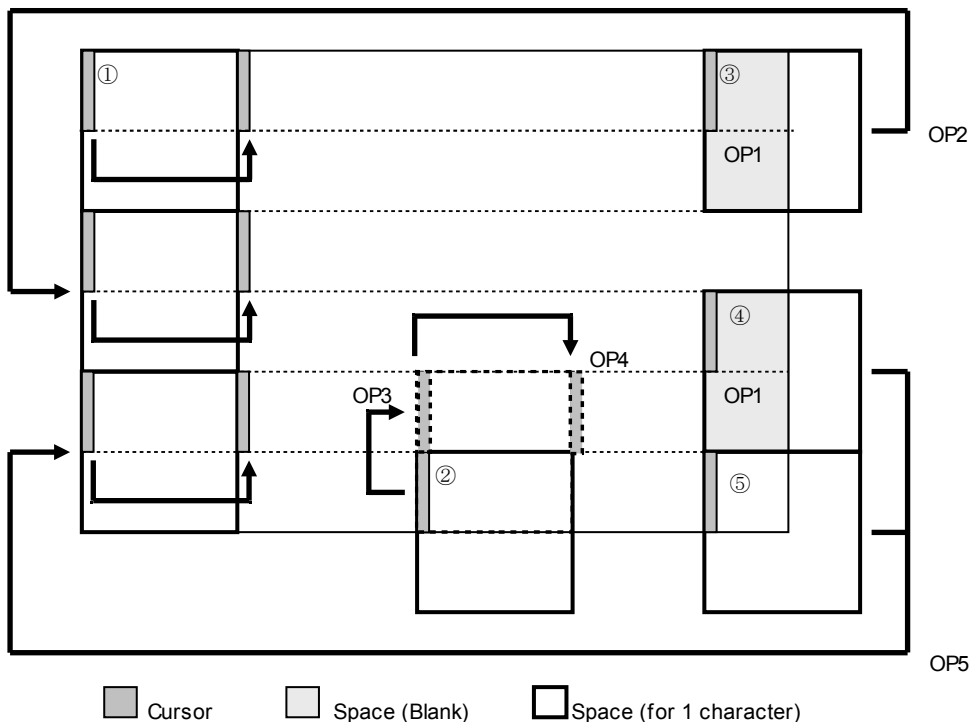

MD3 (Horizontal scroll mode)

| Cursor position | | Figure Number | Display Operation |
|---------------------------------------|--------------------------------|---------------|---|
| X direction | Y direction | | |
| Space for character on right side. | Not right end. | ① | Display character at cursor. Horizontal Tab (HT) (OP2). |
| | Right end (refer to Figure 2). | - | Display character at cursor. Shift to Scroll ON*. |
| | - | ② | No action. Cursor does not move. |
| No space for character on right side. | - | ③ | Contents of current line scroll left until sufficient space for character is available at the right end (OP3). Cursor moves to the left edge of newly-created space (OP1). Display character at cursor. Shift to Scroll ON*. |
| | - | ④ | No action. Cursor does not move. |

* Note: Operation during "Scroll ON":

Contents of current line scroll left until sufficient space for character is available at the right end, then character is displayed at cursor.

"Scroll ON" condition is cancelled by any command that moves the cursor except Character Display or Horizontal Tab.

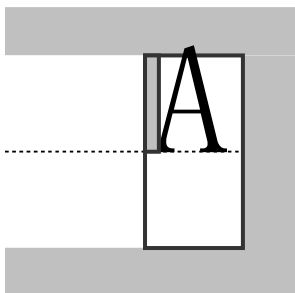
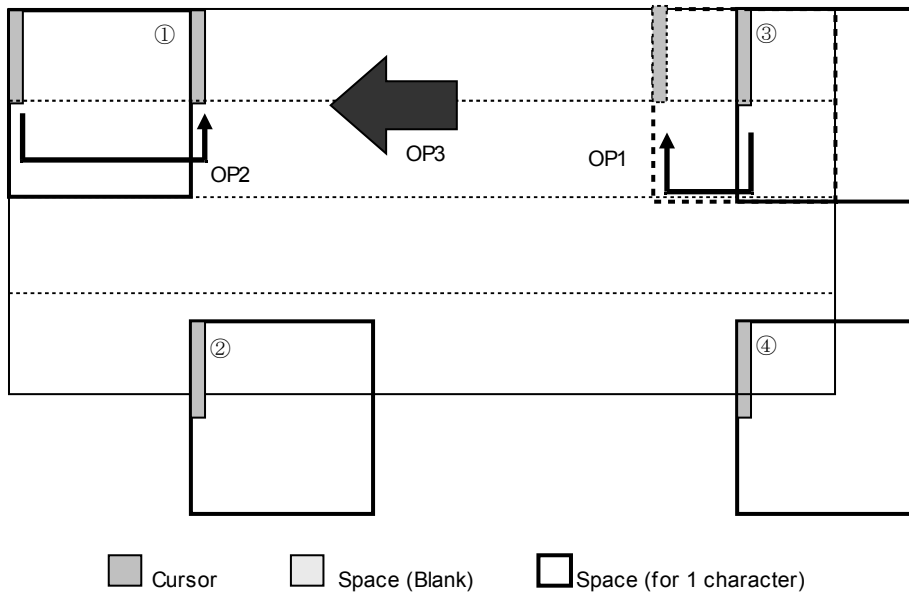

Figure 2

4.7.2.2 BS (Back Space)

Code: 08h

Function: Cursor moves to the left by one character.
This command has effect for the currently-selected window.

MD1 (Over-write mode) and MD2 (Vertical scroll mode)

| Cursor position | | Display Operation |
|--------------------------------------|------------------------------|---|
| X direction | Y direction | |
| Space for character on left side. | - | Cursor moves left by one character. |
| No space for character on left side. | Space for one line above. | Cursor moves to right end of next upper line. |
| | No space for one line above. | Cursor does not move. |

MD3 (Horizontal scroll mode)

| Cursor position | | Display Operation |
|--------------------------------------|-------------|-------------------------------------|
| X direction | Y direction | |
| Space for character on left side. | - | Cursor moves left by one character. |
| No space for character on left side. | - | Cursor does not move. |

4.7.2.3 HT (Horizontal Tab)

Code: 09h

Function: Cursor moves to the right by one character.
This command has effect for the currently-selected window.

MD1 (Over-write mode)

| Cursor position | | Display Operation |
|---------------------------------------|--|--|
| X direction | Y direction | |
| Space for character on right side. | - | Cursor moves right by one character. |
| No space for character on right side. | Space for character in next lower line. | Cursor moves to left end of next lower line. |
| | No space for character in next lower line. | Cursor moves to left end of top line. |

MD2 (Vertical scroll mode)

| Cursor position | | Display Operation |
|---------------------------------------|--|---|
| X direction | Y direction | |
| Space for character on right side. | - | Cursor moves right by one character. |
| No space for character on right side. | Space for character in next lower line. | Cursor moves to left end of next lower line. |
| | No space for character in next lower line. | Display contents are scrolled up the required number of dots, and the bottom line is cleared. Cursor moves to left end of bottom line. |

MD3 (Horizontal scroll mode)

| Cursor position | | | Display Operation |
|---------------------------------------|---|-------------|---|
| X direction | | Y direction | |
| Space for character on right side. | Not right end. | - | Cursor moves right by one character. |
| | Right end (refer to Figure 2, page 13). | | Shift to Scroll ON* |
| No space for character on right side. | - | - | Contents of current line scroll left until sufficient space for character is available at the right end. Cursor moves to the left edge of newly-created space. Shift to Scroll ON*. |

* Note: Operation during "Scroll ON":

Contents of current line scroll left until sufficient space for character is available at the right end (cursor does not move).

"Scroll ON" condition is cancelled by any command that moves the cursor except Character Display or Horizontal Tab.

4.7.2.4 LF (Line Feed)

Code: 0Ah

Function: Cursor moves to next lower line.

This command has effect for the currently-selected window.

MD1 (Over-write mode)

| Cursor position | | Display Operation |
|-----------------|--|---|
| X direction | Y direction | |
| - | Space for character in next lower line. | Cursor moves to the same position on next lower line. |
| | No space for character in next lower line. | Cursor moves to the same position on top line. |

MD2 (Vertical scroll mode)

| Cursor position | | Display Operation |
|-----------------|--|--|
| X direction | Y direction | |
| - | Space for character in next lower line. | Cursor moves to the same position on next lower line. |
| | No space for character in next lower line. | Display contents are scrolled up the required number of dots, and the bottom line is cleared. Cursor does not move. |

MD3 (Horizontal scroll mode)

| Cursor position | | Display Operation |
|-----------------|-------------|-----------------------|
| X direction | Y direction | |
| - | - | Cursor does not move. |

4.7.2.5 HOM (Home Position)

Code: 0Bh

Function: Cursor moves to home position (top left).

This command has effect for the currently-selected window.

4.7.2.6 CR (Carriage Return)

Code: 0Dh

Function: Cursor moves to left end of current line.

This command has effect for the currently-selected window.

4.7.2.7 CLR (Display Clear)

Code: 0Ch

Function: Display screen is cleared and cursor moves to home position.

This command has effect for the currently-selected window.

4.7.2.8 CAN (Line Clear)

Code: 18h

Function: Current line is cleared and cursor moves to left end of current line.

This command has effect for the currently-selected window.

4.7.2.9 RCLR (Line end Clear)

Code: 19h

Function: Current line is cleared from cursor position to end of line (right end).

This command has effect for the currently-selected window.

4.7.3 Command Set

4.7.3.1 General setting commands

| Command Name | Hex Code | Operation | Page |
|--------------------------|---|---|------|
| Brightness level setting | 1Fh,58h,n Default: n=04h or Memory SW setting. | Set brightness level for entire display screen. n=00h: 0% n=01h: 25% n=02h: 50% n=03h: 75% n=04h: 100% n=10h: 0% n=11h: 12.5% n=12h: 25% n=13h: 37.5% n=14h: 50% n=15h: 62.5% n=16h: 75% n=17h: 87.5% n=18h: 100% | p25 |
| Initialize Display | 1Bh,40h | Clear entire display screen and initialize all settings. | p25 |
| Cursor set | 1Fh,24h,xL,xH, yL,yH | Cursor moves to specified x,y position on Display Memory. xL: Cursor position x, lower byte xH: Cursor position x, upper byte yL: Cursor position y, lower byte yH: Cursor position y, upper byte | p25 |
| Cursor display | 1Fh,43h,n Default: n=00h | Cursor display ON/OFF select. n=00h: Cursor OFF n=01h: Cursor ON | p25 |

4.7.3.2 Character display setting commands

| Command Name | Hex Code | Operation | Page |
|----------------------------------|---|--|------|
| Write screen mode select | 1Fh,28h,77h,10h,a Default: a=00h or Memory SW setting. | Sets the write screen mode for base window. a=00h: Display screen mode a=01h: All screen mode | p26 |
| International font set | 1Bh,52h,n Default: n=00h or Memory SW setting. | Some characters codes within the range 20h – 7Fh are selected from the types listed below. n=00h: America n=01h: France n=02h: Germany n=03h: England n=04h: Denmark 1 n=05h: Sweden n=06h: Italy n=07h: Spain1 n=08h: Japan n=09h: Norway n=0Ah: Denmark2 n=0Bh: Spain2 n=0Ch: Latin America n=0Dh: Korea | p26 |
| Character Table type | 1Bh,74h,n Default: n=00h or Memory SW setting. | Character codes in the range 80h – FFh are selected from the types listed below. n=00h: PC437 (USA: Standard Europe) n=01h: Katakana n=02h: PC850 (Multilingual) n=03h: PC860 (Portuguese) n=04h: PC863 (Canadian-French) n=05h: PC865 (Nordic) n=10h: WPC1252 n=11h: PC866 (Cyrillic #2) n=12h: PC852 (Latin 2), n=13h: PC858 n=FFh: User table | p27 |
| Over-write mode | 1Fh,01h | Set Over-write mode. | p27 |
| Vertical scroll mode | 1Fh,02h | Set Vertical scroll mode. | p27 |
| Horizontal scroll mode | 1Fh,03h | Set Horizontal scroll mode. | p27 |
| Horizontal scroll mode Scroll ON | 1Fh,05h | Set Horizontal scroll mode Scroll ON. | p27 |
| Horizontal scroll speed | 1Fh,73h,n Default: n=00h or Memory SW setting. | Set Horizontal scroll speed. | p27 |
| Font size select | 1Fh,28h,67h,01h,m Default: m=01h or Memory SW setting. | Select font size of a character. m=01h: 6×8 font m=02h: 8×16 font m=03h: 12×24 font m=04h: 16×32 font | p28 |
| 2-byte character | 1Fh,28h,67h,02h,m Default: m=00h or Memory SW setting. | Sets 2-byte character ON/OFF. m=01h: 2-byte character mode ON m=00h: 2-byte character mode OFF | p28 |

| Command Name | Hex Code | Operation | Page |
|-----------------------|--|---|------|
| 2-byte character type | 1Fh,28h,67h,03h, m Default: m=00h or Memory SW setting. | Sets 2-byte character type. m=00h: Japanese m=01h: Korean m=02h: Simplified Chinese m=03h: Traditional Chinese | p28 |
| Font width | 1Fh,28h,67h,04h, m Default: m=00h | Character width select. m=00h: Fixed width m=02h: Proportional 1 m=03h: Proportional 2 m=04h: Proportional 3 | p29 |
| FROM extended font | 1Fh,28h,67h,05h,n Default: n=00h | FROM extended font select. n=00h: Normal font n=01h – FFh: FROM extended font | p30 |
| Font magnification | 1Fh,28h,67h,40h, x,y Default: x=01h, y=01h or Memory SW setting. | Magnify the character by x times on the right, y times downward. x: X magnification factor y: Y magnification factor | p30 |
| Bold character | 1Fh,28h,67h,41h,b Default: b=00h or Memory SW setting. | Set or cancel cancel boldface character. b = 00h: Cancels Bold b = 01h: Selects Bold | p30 |

4.7.3.3 Display action setting commands

| Command Name | Hex Code | Operation | Page |
|-------------------------------|---|--|------|
| Wait | 1Fh,28h,61h,01h,t | Processing is stopped for the specified time. t: Wait time (× approximately 0.5s) | p30 |
| Short Wait | 1Fh,28h,61h,02h,t | Processing is stopped for the specified time. t: Wait time (× module timing unit) (Ref: 3.1 Timing Unit) | p30 |
| Scroll display action | 1Fh,28h,61h,10h, wL,wH,cL,cH,s | Shifts the display screen, enabling horizontal display screen scroll action. wL: Display screen shift byte count, lower byte wH: Display screen shift byte count, upper byte cL: Number of cycles, lower byte cH: Number of cycles, upper byte s: Scroll speed | p31 |
| Blink | 1Fh,28h,61h,11h, p,t1,t2,c | Blink display action on display screen. p: Blink pattern t1: Normal display time t2: Blank or Reverse display time c: Number of cycles | p31 |
| Curtain display action | 1Fh,28h,61h,12h, v,s,p | Curtain display action on display screen. v: Direction of Curtain action s: Curtain action speed p: Curtain action pattern | p32 |
| Spring display action | 1Fh,28h,61h,13h, v,s,pL,pH | Spring display action on display screen. v: Direction of spring action s: Spring action speed pL: Display Memory pattern address, lower byte pH: Display Memory pattern address, upper byte | p32 |
| Random display action | 1Fh,28h,61h,14h, s,pL,pH | Random display action on display screen. s: Random display action speed pL: Display Memory pattern address, lower byte pH: Display Memory pattern address, upper byte | p33 |
| Display power ON/OFF/auto-OFF | 1Fh,28h,61h,40h,p Default: p=01h | Controls display power ON/OFF/auto-OFF. p=00h: Display power OFF p=01h: Display power ON p=10h: Display power auto-OFF | p34 |
| Display power auto-OFF time | 1Fh,28h,61h,40h, 11h,t Default: t=1Eh | Sets the display power auto-OFF time. t: Auto-OFF time | p34 |

4.7.3.4 Bit image display setting commands

| Command Name | Hex Code | Operation | Page |
|---------------------------------------|--|---|------|
| Dot drawing | 1Fh,28h,64h,10h, pen,xL,xH,yL,yH | Display the dot pattern on a drawing position or delete the dot pattern already displayed. pen: Dot display ON or OFF xL: Dot pattern drawing position x, lower byte xH: Dot pattern drawing position x, upper byte yL: Dot pattern drawing position y, lower byte yH: Dot pattern drawing position y, upper byte | p34 |
| Line/Box pattern drawing | 1Fh,28h,64h,11h, mode,pen, x1L,x1H,y1L,y1H, x2L,x2H,y2L,y2H | Display the Line, Box, Box FILL on the drawing area specified by x1,y1,x2,y2 or delete the dot pattern already displayed. mode: Drawing mode select pen: Dot ON or OFF x1L: Line/Box pattern drawing start position x1, lower byte x1H: Line/Box pattern drawing start position x1, upper byte y1L: Line/Box pattern drawing start position y1, lower byte y1H: Line/Box pattern drawing start position y1, upper byte x2L: Line/Box pattern drawing end position x2, lower byte x2H: Line/Box pattern drawing end position x2, upper byte y2L: Line/Box pattern drawing end position y2, lower byte y2H: Line/Box pattern drawing end position y2, upper byte | p34 |
| Dot unit downloaded bit image display | 1Fh,28h,64h,20h, xPL,xPH,yPL,yPH, m, aL,aH,aE, ySL,ySH, xOL,xOH, yOL,yOH, xL,xH,yL,yH,01h | Display the bit image defined in RAM or FROM at the specified (x,y) position. xPL: Display position x, lower byte (by 1 dot) xPH: Display position x, upper byte (by 1 dot) yPL: Display position y, lower byte (by 1 dot) yPH: Display position y, upper byte (by 1 dot) m: Image data display memory select aL: Bit image data definition address, lower byte aH: Bit image data definition address, upper byte aE: Bit image data definition address, extension byte ySL: Bit image defined, Y size, lower byte (by 8 dots) ySH: Bit image defined, Y size, upper byte (by 8 dots) xOL: Image data offset x, lower byte (by 1 dot) xOH: Image data offset x, upper byte (by 1 dot) yOL: Image data offset y, lower byte (by 1 dot) yOH: Image data offset y, upper byte (by 1 dot) xL: Bit image display X size, lower byte (by 1 dot) xH: Bit image display X size, upper byte (by 1 dot) yL: Bit image display Y size, lower byte (by 1 dot) yH: Bit image display Y size, upper byte (by 1 dot) | p36 |
| Dot unit real-time bit image display | 1Fh,28h,64h,21h, xPL,xPH,yPL,yPH, xL,xH,yL,yH, 01h,d(1)...d(k) | Display the bit image data at the specified (x,y) position in real-time. xPL: Display position x, lower byte (by 1 dot) xPH: Display position x, upper byte (by 1 dot) yPL: Display position y, lower byte (by 1 dot) yPH: Display position y, upper byte (by 1 dot) xL: Bit image display X size, lower byte (by 1 dot) xH: Bit image display X size, upper byte (by 1 dot) yL: Bit image display Y size, lower byte (by 1 dot) yH: Bit image display Y size, upper byte (by 1 dot) d(1)...d(k): Image data | p39 |
| Dot unit character display | 1Fh,28h,64h,30h, xPL,xPH,yPL,yPH, m,bLen, d(1)...d(bLen) | Display the specified text characters at the specified (x,y) position. xPL: Display position x, lower byte (by 1 dot) xPH: Display position x, upper byte (by 1 dot) yPL: Display position y, lower byte (by 1 dot) yPH: Display position y, upper byte (by 1 dot) m: Response select bLen: Character data length d(1)...d(bLen): Character data / reverse select | p41 |
| Real-time bit image display | 1Fh,28h,66h,11h, xL,xH,yL,yH,01h, d(1)...d(k) | Display the supplied bit image data on the cursor position in real-time. xL: Bit image X size, lower byte (by 1 dot) xH: Bit image X size, upper byte (by 1 dot) yL: Bit image Y size, lower byte (by 8 dots) yH: Bit image Y size, upper byte (by 8 dots) d(1)...d(k): Image data | p42 |

GU-3900B series "General Function" Software Specification

| Command Name | Hex Code | Operation | Page |
|--|--|---|------|
| RAM bit image definition | 1Fh,28h,66h,01h, aL,aH,aE,sL,sH,sE, d(1)...d(s) | Define user bit image to RAM. aL: Bit image data definition address, lower byte aH: Bit image data definition address, upper byte aE: Bit image data definition address, extension byte sL: Bit image data length, lower byte sH: Bit image data length, upper byte sE: Bit image data length, extension byte d(1)...d(s): Image data | p43 |
| FROM bit image definition (Only valid in User setup mode) | 1Fh,28h,65h,10h, aL,aH,aE,sL,sH,sE, d(1)...d(s) | Define user bit image to FROM. aL: Bit image data definition address, lower byte aH: Bit image data definition address, upper byte aE: Bit image data definition address, extension byte sL: Bit image data length, lower byte sH: Bit image data length, upper byte sE: Bit image data length, extension byte d(1)...d(s): Image data | p44 |
| Downloaded bit image display | 1Fh,28h,66h,10h,m, aL,aH,aE, ySL,ySH, xL,xH,yL,yH,01h | Display the RAM or FROM bit image defined on cursor position. m: Select bit image data memory aL: Bit image data definition address, lower byte aH: Bit image data definition address, upper byte aE: Bit image data definition address, extension byte ySL: Bit image defined Y size, lower byte (by 8 dots) ySH: Bit image defined Y size, upper byte (by 8 dots) xL: Bit image display X size, lower byte (by 1 dot) xH: Bit image display X size, upper byte (by 1 dot) yL: Bit image display Y size, lower byte (by 8 dots) yH: Bit image display Y size, upper byte (by 8 dots) | p46 |
| Downloaded bit image scroll display | 1Fh,28h,66h,90h,m, aL,aH,aE, ySL,ySH, xL,xH,yL,yH,01h,s | Scroll display the RAM, FROM or Display Memory bit image from the right end of current window. m: Select bit image data memory aL: Bit image data definition address, lower byte aH: Bit image data definition address, upper byte aE: Bit image data definition address, extension byte ySL: Bit image defined Y size, lower byte (by 8 dots) ySH: Bit image defined Y size, upper byte (by 8 dots) xL: Bit image scroll display X size, lower byte (by 1 dot) xH: Bit image scroll display X size, upper byte (by 1 dot) yL: Bit image scroll display Y size, lower byte (by 8 dots) yH: Bit image scroll display Y size, upper byte (by 8 dots) s: Scroll speed | p48 |

4.7.3.5 General display setting commands

| Command Name | Hex Code | Operation | Page |
|--|---|--|------|
| Horizontal scroll display quality select | 1Fh,60h,n Default: n=00h or Memory SW setting. | Sets the visual quality of horizontal scroll. n=00h: Scroll speed-priority n=01h: Visual quality-priority | p50 |
| Reverse display | 1Fh,72h,n Default: n=00h or Memory SW setting. | Reverse display setting ON/OFF. n=00h: Reverse display OFF n=01h: Reverse display ON | p50 |
| Write mixture display mode | 1Fh,77h,n Default: n=00h or Memory SW setting. | Sets the write mixture mode. New character or graphic image data is mixed with the current display image when written to the Display Memory. n=00h: Normal display write (not mixture display) n=01h: OR display write, n=02h: AND display write n=03h: EX-OR display write | p50 |

4.7.3.6 Window display setting commands

| Command Name | Hex Code | Operation | Page |
|-----------------------------|---|--|------|
| Window select | 1Fh,28h,77h,01h,a | Selects current window. a=00h: Base-Window, a=01h: User-Window 1 a=02h: User-Window 2, a=03h: User-Window 3 a=04h: User-Window 4 | p50 |
| User Window define / cancel | 1Fh,28h,77h,02h,a,b,xPL,xPH,yPL,yPH,xSL,xSH,ySL,ySH | Define or Cancel User-Window a: Definable window No. b: Define or Cancel xPL: Left position of window, lower byte (by 1 dot) xPH: Left position of window, upper byte (by 1 dot) yPL: Top position of window, lower byte (by 8 dots) yPH: Top position of window, upper byte (by 8 dots) xSL: X size of window, lower byte (by 1 dot) xSH: X size of window, upper byte (by 1 dot) ySL: Y size of window, lower byte (by 8 dots) ySH: Y size of window, upper byte (by 8 dots) | p51 |

4.7.3.7 Download character setting commands

| Command Name | Hex Code | Operation | Page |
|-------------------------------------|---|---|------|
| Download character ON/OFF | 1Bh,25h,n Default: n=00h | Enable or disable display of download characters. n=01h: Enable, n=00h: Disable | p52 |
| Download character definition | 1Bh,26h,a,c1,c2,x[1,d1...dx1,xk,d1...dxk] | Define 6×8, 8×16, 12×24, or 16×32 dot download characters into RAM. a: Select character type c1: Start character code c2: End character code x: Number of dots for X direction d1...dxk: Definition data | p52 |
| Download character delete | 1Bh,3Fh,a,c | Delete defined 6×8, 8×16, 12×24, or 16×32 dot download character. a: Select character type c: Delete character code | p52 |
| 16×16 Download character definition | 1Fh,28h,67h,10h,c1,c2,d1...d32 | Define 16×16 dot download characters into RAM. c1: Character code, upper byte c2: Character code, lower byte d: Definition data | p53 |
| 16×16 Downloaded character delete | 1Fh,28h,67h,11h,c1,c2 | Delete defined 16×16 dot download character. c1: Delete character code, upper byte c2: Delete character code, lower byte | p53 |
| 32×32 Download character definition | 1Fh,28h,67h,14h,c1,c2,d1...d128 | Define 32×32 dot download characters into RAM. c1: Character code, upper byte c2: Character code, lower byte d: Definition data | p53 |
| 32×32 Downloaded character delete | 1Fh,28h,67h,15h,c1,c2 | Delete defined 32×32 dot download character. c1: Delete character code, upper byte c2: Delete character code, lower byte | p54 |

| Command Name | Hex Code | Operation | Page |
|--|---|---|------|
| Download character save (Only valid in User setup mode) | 1Fh,28h,65h,11h,a | Save the download characters defined on RAM to FROM. a: Font size a=01h: 6×8 dot a=02h: 8×16 dot a=03h: 16×16 dot a=04h: 16×32 dot a=05h: 32×32 dot a=06h: 12×24 dot | p54 |
| Download character restore | 1Fh,28h,65h,21h,a | Transfer the download characters saved in FROM to RAM. a: Font size a=01h: 6×8 dot a=02h: 8×16 dot a=03h: 16×16 dot a=04h: 16×32 dot a=05h: 32×32 dot a=06h: 12×24 dot | p54 |
| FROM user font definition (Only valid in User setup mode) | 1Fh,28h,65h,13h,m, P(80h-1),P(80h-2),- P(FFh-n) | Define the user font for each size of 1-byte code to the user table. m: User table m=01h: 6×8 dot m=02h: 8×16 dot m=03h: 12×24 dot m=04h: 16×32 dot p: Definition data | p55 |
| FROM extension font definition | 1Fh,28h,65h,15h, a,b,p(1)...p(65536) | Define or delete FROM extension font a: Bank b: Define / Delete p: Definition data (if Define) | p55 |

4.7.3.8 User setup mode setting commands

| Command Name | Hex Code | Operation | Page |
|--|---------------------------------|------------------------|------|
| User setup mode start | 1Fh,28h,65h,01h, 49h,4Eh | User setup mode start. | p55 |
| User setup mode end (Only valid in User setup mode) | 1Fh,28h,65h,02h, 4Fh,55h,54h | User setup mode end. | p55 |

4.7.3.9 General-purpose I/O Port control commands

| Command Name | Hex Code | Operation | Page |
|---------------------------------|-------------------------|---|------|
| I/O Port Input / Output setting | 1Fh,28h,70h,01h, n,a | Set input or output for general-purpose I/O ports. n: I/O port number n=00h: Port 0, n=01h: Port 1 a: Set Input / Output (bit-wise) bit = 0: Input bit = 1: Output | p56 |
| I/O Port Output | 1Fh,28h,70h,10h, n,a | Output data to general-purpose I/O port. n: I/O port number n=00h: Port 0, n=01h: Port 1 a: Output data value | p56 |
| I/O Port Input | 1Fh,28h,70h,20h,n | The state of a general-purpose I/O port is transmitted via returned. n: I/O port number n=00h: Port 0, n=01h: Port 1 | p56 |

4.7.3.10 Macro setting commands

| Command Name | Hex Code | Operation | Page |
|---|--|--|------|
| RAM Macro define / delete | 1Fh,3Ah,pL,pH, d1...dk | Define or delete RAM Macro or RAM Program Macro. pL: RAM Macro data length, lower byte pH: RAM Macro data length, upper byte d1...dk: RAM Macro data | p57 |
| FROM Macro define / delete (Only valid in User setup mode) | 1Fh,28h,65h,12h, a,pL,pH,t1,t2, d(1)...d(p) | Define or delete FROM Macro or FROM Program Macro. a: FROM Macro definition number pL: FROM Macro data length, lower byte pH: FROM Macro data length, upper byte t1: Display time interval t2: Idle time for Macro repetition d(1)...d(P): FROM Macro data | p57 |
| Macro execution | 1Fh,5Eh,a,t1,t2 | Continuously execute Macro. a: Macro processing definition number a=00h: RAM Macro a=01h–04h: FROM Macro 1–4 a=80h: RAM Program Macro a=81h–84h: FROM Program Macro 1–4 t1: Display time interval t2: Idle time for Macro repetition | p58 |
| Macro end condition | 1Fh,28h,69h,20h, a,b,c Default: a=00h, b=00h, c=00h or Memory SW setting. | Macro end condition set. (Not applicable for Program Macro) a: Macro end code Enable/Disable b: Macro end code c: Macro end Clear Screen setting | p59 |

4.7.3.11 Other setting commands

| Command Name | Hex Code | Operation | Page |
|--|--|--|------|
| Memory SW setting (Only valid in User setup mode) | 1Fh,28h,65h,03h, a,b 1Fh,28h,65h,03h, a,b,c[1],d[1] [...c[b],d[b]] | Set Memory SW. Single setting: a: Memory SW number b: Setting value Multiple setting (a=FFh): b: Number of settings c: Memory SW number d: Setting value | p59 |
| Memory SW data send | 1Fh,28h,65h,04h,a 1Fh,28h,65h,04h, a,b,c[1] [...c[b]] | Send the contents of Memory SW data. Single read: a: Memory SW number Multiple read: (a=FFh) b: No. of reads c: Memory SW number | p60 |
| General-purpose memory store | 1Fh,28h,65h,18h, sL,sH,sE,m1, a1L,a1H,a1E, d[1]...d[s] | Store the supplied data into general-purpose memory. sL: Data size, lower byte sH: Data size, upper byte sE: Data size, extension byte m1: Memory select a1L: Memory address, lower byte a1H: Memory address, upper byte a1E: Memory address, extension byte d: Data to store | p60 |
| General-purpose memory transfer | 1Fh,28h,65h,19h, sL,sH,sE,m1, a1L,a1H,a1E,m2, a2L,a2H,a2E | Transfer data between general-purpose memory areas. sL: Transfer size, lower byte sH: Transfer size, upper byte sE: Transfer size, extension byte m1: Destination memory select a1L: Destination address, lower byte a1H: Destination address, upper byte a1E: Destination address, extension byte m2: Source memory select a2L: Source address, lower byte a2H: Source address, upper byte a2E: Source address, extension byte | p61 |

GU-3900B series "General Function" Software Specification

| Command Name | Hex Code | Operation | Page |
|-----------------------------|---|---|------|
| General-purpose memory send | 1Fh,28h,65h,28h, sL,sH,sE,m1, a1L,a1H,a1E | Send data stored in general-purpose memory. sL: Data size, lower byte sH: Data size, upper byte sE: Data size, extension byte m1: Memory select a1L: Memory address, lower byte a1H: Memory address, upper byte a1E: Memory address, extension byte | p61 |
| Display status send | 1Fh,28h,65h,40h, a,b,c | Send display status information. a: Information name a=01h: Boot version information a=02h: Firmware version information a=10h: 2-byte character code information a=11h: Language type information a=20h: Memory checksum information a=30h: Product information a=40h: Display x dot information a=41h: Display y dot information b: Start address c: Data length | p62 |
| RS-232 serial settings | 1Fh,28h,69h,10h, a,b | Change the RS-232 serial interface communication parameters. a: Baud rate setting a=00h: 19200 bps a=01h: 4800 bps a=02h: 9600 bps a=03h: 19200 bps a=04h: 38400 bps a=05h: 57600 bps a=06h: 115200 bps 07h ≤ a ≤ 0Bh: Setting prohibited b: Parity setting b=00h: No parity b=01h: Even parity b=02h: Odd parity | p62 |
| Memory re-write mode | 1Ch,7Ch,4Dh, D0h,4Dh,4Fh,44h, 45h,49h,4Eh | Shift to "Memory re-write mode" from "Normal mode". | p62 |

4.7.4 Command Set Details

4.7.4.1 US X n (Brightness level setting)

Code: 1Fh 58h n

n: Brightness level setting

Definable area: 00h ≤ n ≤ 04h, 10h ≤ n ≤ 18h

Default: n = 04h or Memory SW setting.

Function: Set display brightness level.

n: Level

| n | Brightness level | n | Brightness level |
|-----|------------------|-----|------------------|
| 00h | 0% | 12h | 25% |
| 01h | 25% | 13h | 37.5% |
| 02h | 50% | 14h | 50% |
| 03h | 75% | 15h | 62.5% |
| 04h | 100% | 16h | 75% |
| 10h | 0% | 17h | 87.5% |
| 11h | 12.5% | 18h | 100% |

4.7.4.2 ESC @ (Initialize Display)

Code: 1Bh 40h

Settings return to default values.

DIP Switch is not re-loaded.

Contents of receive buffer remain in memory.

4.7.4.3 US \$ x y (Cursor Set)

Code: 1Fh 24h xL xH yL yH

xL: Cursor position x, lower byte (1 dot / unit)

xH: Cursor position x, upper byte (1 dot / unit)

yL: Cursor position y, lower byte (8 dots / unit)

yH: Cursor position y, upper byte (8 dots / unit)

Definable area: 0000h ≤ (xL + xH×100h) ≤ Max_Xdot

0000h ≤ (yL + yH×100h) ≤ Max_Ybyte

Function: Cursor moves to the specified (X, Y) position on Display Memory.

If the specified X, Y position (X and/or Y) is outside the definable area, the command is ignored and the cursor remains in the same position.

This command has effect for the currently-selected window.

4.7.4.4 US C n (Cursor display ON/OFF)

Code: 1Fh 43h n

n: Cursor display setting

Definable area: 00h ≤ n ≤ 01h

n = 00h: Cursor display OFF

n = 01h: Cursor display ON

Default: n = 00h (Cursor OFF)

Function: Cursor display setting.

When cursor display is ON, cursor position appears as reverse blinking, 1×8 dots.

When cursor is in hidden area, it does not appear, even when cursor display is set ON.

This command has effect for the currently-selected window.

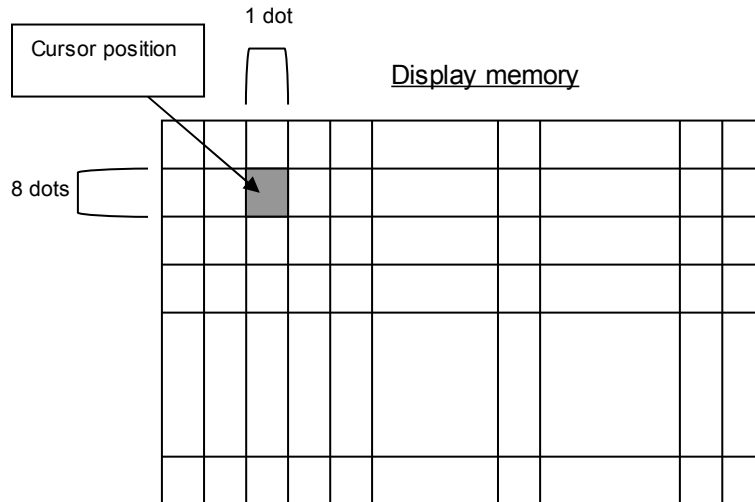

4.7.4.5 US (w 10h a (Write screen mode select)

Code: 1Fh 28h 77h 10h a

- a: Write screen mode
- a = 00h: Display screen mode
- a = 01h: All screen mode

Definable area: 00h ≤ a ≤ 01h

Default: a = 00h or Memory SW setting.

Function: Select the write screen mode. **This setting is only applicable for Base-Window.**

Display screen mode: Display action is valid within area of either Display area or Hidden area, depending on cursor position.

All screen mode: Display action is valid over the entire display memory.

4.7.4.6 ESC R n (International font set)

Code: 1Bh 52h n

Definable area: 00h ≤ n ≤ 0Dh

Default: n = 00h or Memory SW setting.

Function: Select international font set.

| n | Font set |
|-----|---------------|
| 00h | America |
| 01h | France |
| 02h | Germany |
| 03h | England |
| 04h | Denmark 1 |
| 05h | Sweden |
| 06h | Italy |
| 07h | Spain1 |
| 08h | Japan |
| 09h | Norway |
| 0Ah | Denmark2 |
| 0Bh | Spain2 |
| 0Ch | Latin America |
| 0Dh | Korea |

Characters already displayed are not affected.

4.7.4.7 ESC t n (Character table type)

Code: 1Bh 74h n

Definable area: n = 00h, 01h, 02h, 03h, 04h, 05h, 10h, 11h, 12h, 13h, FFh

Default: n = 0 or Memory SW setting.

Function: Select Character table type.

Characters already displayed are not affected.

FFh (User table): The user-defined font table (refer to FROM user font definition command).

| n | Font code type |
|-----|-------------------------|
| 00h | PC437(USA – Euro std) |
| 01h | Katakana – Japanese |
| 02h | PC850 (Multilingual) |
| 03h | PC860 (Portuguese) |
| 04h | PC863 (Canadian-French) |
| 05h | PC865 (Nordic) |
| 10h | WPC1252 |
| 11h | PC866 (Cyrillic #2) |
| 12h | PC852 (Latin 2) |
| 13h | PC858 |
| FFh | User table |

4.7.4.8 US MD1 (Over-write mode)

Code: 1Fh 01h

Function: Display mode set to Over-write mode.

This command has effect for the currently-selected window.

4.7.4.9 US MD2 (Vertical scroll mode)

Code: 1Fh 02h

Function: Display mode set to Vertical scroll mode.

This command has effect for the currently-selected window.

4.7.4.10 US MD3 (Horizontal scroll mode)

Code: 1Fh 03h

Function: Display mode set to Horizontal scroll mode.

This command has effect for the currently-selected window.

4.7.4.11 US MD5 (Horizontal scroll mode, scroll ON)

Code: 1Fh 05h

Function: Display mode set to Horizontal scroll mode, scroll ON state.

After this command, operation is same as MD3 mode.

This command has effect for the currently-selected window.

4.7.4.12 US s n (Horizontal scroll speed)

Code: 1Fh 73h n

Definable area: $00 \leq n \leq 1Fh$

Default: n = 00h or Memory SW setting.

Function: Set speed for Horizontal scroll mode.

Scroll speed is set by n.

Subsequent commands are not processed until scroll is completed.

Scroll base time period "T" = module timing unit, but may be longer due to screen mode or character size, etc. Refer to 3.1 Timing Unit.

| n | Speed |
|-----------|------------------|
| 00h | Instantaneous |
| 01h | T ms / 2 dots |
| 02h – 1Fh | (n-1)×T ms / dot |

Note: Scroll speed is approximate. Depending on the scrolling area, scroll may reduce in speed or flicker. See also 4.7.4.39 Horizontal scroll display quality select.

4.7.4.13 US (g 01h m (Font size select)

Code: 1Fh 28h 67h 01h m

Definable area: m = 01h, 02h, 03h, 04h

Default: m = 01h or Memory SW setting.

Function: Sets the font size for 1-byte characters.

| m | Function |
|-----|---------------------|
| 01h | 6×8 dot character |
| 02h | 8×16 dot character |
| 03h | 12×24 dot character |
| 04h | 16×32 dot character |

4.7.4.14 US (g 02h m (2-byte character)

Code: 1Fh 28h 67h 02h m

Definable area: m = 00h, 01h

Default: m = 00h or Memory SW setting.

Function: Sets 2-byte character ON/OFF.

| m | Function |
|-----|---------------------------|
| 00h | 2-byte character mode OFF |
| 01h | 2-byte character mode ON |

4.7.4.15 US (g 03h m, US (g 0Fh m (2-byte character type)

Code: 1Fh 28h 67h 03h m

1Fh 28h 67h 0Fh m

Definable area: m = 00h, 01h, 02h, 03h

Default: m = 00h or Memory SW setting.

Function: Sets 2-byte character type.

| m | Function | Code type |
|-----|---------------------|-----------------------|
| 00h | Japanese | JIS X0208 (Shift-JIS) |
| 01h | Korean | KSC5601-87 |
| 02h | Simplified Chinese | GB2312-80 |
| 03h | Traditional Chinese | Big-5 |

To display a 16×16 dot, 2-byte character:

Font size select: Code:1Fh 28h 67h 01h **02h**

2-byte character ON: Code:1Fh 28h 67h 02h **01h**

2-byte character type: Code:1Fh 28h 67h 03h 00h Japanese

1Fh 28h 67h 03h 01h Korean

1Fh 28h 67h 03h 02h Simplified Chinese

1Fh 28h 67h 03h 03h Traditional Chinese

2-byte character code input: Code: 88h 9Fh (“𠄎” Example Japanese character)

4.7.4.16 US (g 04h m (Font Width)

Code: 1Fh 28h 67h 04h m

m: Font width setting

Definable area: m = 00h, 02h, 03h, 04h

Default: m = 00h

Function: Sets the character width.

For fixed-width font, all characters are displayed as font size.

For proportional font, characters are displayed as:

display width = right blank + character width + left blank

6×8 dot character

| m | Character width | Left blank dots | Right blank dots | Space (20h) character width |
|-----|-----------------|-----------------|------------------|-----------------------------|
| 00h | Fixed-width | 0 | 0 | 6 |
| 02h | Proportional 1 | 0 | 1 | 2 |
| 03h | Proportional 2 | 1 | 1 | 2 |
| 04h | Proportional 3 | 2 | 2 | 2 |

8×16 dot character

| m | Character width | Left blank dots | Right blank dots | Space (20h) character width |
|-----|-----------------|-----------------|------------------|-----------------------------|
| 00h | Fixed-width | 0 | 0 | 8 |
| 02h | Proportional 1 | 0 | 1 | 4 |
| 03h | Proportional 2 | 1 | 1 | 4 |
| 04h | Proportional 3 | 2 | 2 | 4 |

12×24 dot character

| m | Character width | Left blank dots | Right blank dots | Space (20h) character width |
|-----|-----------------|-----------------|------------------|-----------------------------|
| 00h | Fixed-width | 0 | 0 | 12 |
| 02h | Proportional 1 | 0 | 2 | 6 |
| 03h | Proportional 2 | 2 | 2 | 6 |
| 04h | Proportional 3 | 4 | 4 | 6 |

16×32 dot character

| m | Character width | Left blank dots | Right blank dots | Space (20h) character width |
|-----|-----------------|-----------------|------------------|-----------------------------|
| 00h | Fixed-width | 0 | 0 | 16 |
| 02h | Proportional 1 | 0 | 2 | 8 |
| 03h | Proportional 2 | 2 | 2 | 8 |
| 04h | Proportional 3 | 4 | 4 | 8 |

Example: Proportional 2, 6×8 dot character 'l'

| | | | | |
|------------|-----------------|--|-------------|--|
| | | | | |
| | | | | |
| | | | | |
| | | | | |
| | | | | |
| | | | | |
| | | | | |
| | | | | |
| Left blank | Character width | | Right blank | |

4.7.4.17 US (g 05h n (FROM Extended Font)**Code: 1Fh 28h 67h 05h n**

n: FROM Extended Font select

Definable area: 00h ≤ n ≤ FFh

Default: n = 00h

Function: n=00h: Normal font.

n=01h–FFh: FROM Extended Font (if FROM Extended Font is defined).

4.7.4.18 US (g 40h x y (Font Magnification)**Code: 1Fh 28h 67h 40h x y**

x: X magnification factor

y: Y magnification factor

Definable area: 01h ≤ x ≤ 04h

01h ≤ y ≤ 04h (Ydots ≥ 40h)

01h ≤ y ≤ 02h (Ydots = 20h)

01h ≤ y ≤ 01h (Ydots = 10h)

Default: x = 01h or Memory SW setting.

y = 01h or Memory SW setting.

Function: Set character magnification 'x' times to the right and 'y' times downward.

4.7.4.19 US (g 41h b (Bold character)**Code: 1Fh 28h 67h 41h b**

b: Bold

Definable area: 00h ≤ b ≤ 01h

b = 00h: Bold OFF / b = 01h: Bold ON

Default: b = 00h or Memory SW setting.

Function: Boldface character ON/OFF (*Boldface may reduce legibility*)**4.7.4.20 US (a 01h t (Wait)****Code: 1Fh 28h 61h 01h t**

t: Wait time

Definable area: 00h ≤ t ≤ FFh

Function: Waits for the specified time (command and data processing is stopped).

Wait time = t × approximately 0.5s

Command / data processing does not resume until wait time is completed.

It is possible to interrupt this command if the command is defined and run in a Macro.

4.7.4.21 US (a 02h t (Short Wait)**Code: 1Fh 28h 61h 02h t**

t: Wait time

Definable area: 00h ≤ t ≤ FFh

Function: Waits for the specified time (command and data processing is stopped).

Wait time = t × module timing unit (refer to 3.1 Timing Unit)

Command / data processing does not resume until wait time is completed.

It is possible to interrupt this command if the command is defined and run in a Macro.

4.7.4.22 US (a 10h wL wH cL cH s (Scroll display action)

Code: 1Fh 28h 61h 10h wL wH cL cH s

- wL: Display screen shift byte count, lower byte
- wH: Display screen shift byte count, upper byte
- cL: Number of cycles, lower byte
- cH: Number of cycles, upper byte
- s: Scroll speed

Definable area: $0000h \leq (wL + wH \times 100h) \leq \text{Max_DispMemAddr}$
 $0001h \leq (cL + cH \times 100h) \leq \text{FFFFh}$
 $00h \leq s \leq \text{FFh}$

Function: Shift the display screen.

Horizontal scrolling is possible by specifying as the shift byte count a multiple of Ybytes. Display switching is possible by specifying shift byte count as (Display screen "x" dot × Ybytes). Scroll speed is specified by 's'.

Scroll speed: $s \times \text{module timing unit} / \text{shift}$ (refer to 3.1 Timing Unit)

Command / data processing does not resume until wait time is completed.

It is possible to interrupt this command if the command is defined and run in a Macro.

For example: 1 dot scroll to the left: wL=08h, wH=00h, 256×64 dot module.

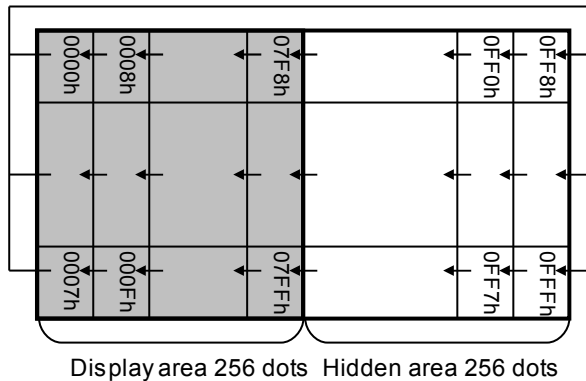

4.7.4.23 US (a 11h p t1 t2 c (Blink)

Code: 1Fh 28h 61h 11h p t1 t2 c

- p: Blink pattern
- t1: Normal display time
- t2: Blank or reverse display time
- c: Number of cycles

Definable area: $00h \leq p \leq 02h$
 $p=00h$: Normal display.
 $p=01h$: Blink display (alternately Normal and Blank display).
 $p=02h$: Blink display (alternately Normal and Reverse display).
 $01h \leq t1 \leq \text{FFh}$
 $01h \leq t2 \leq \text{FFh}$
 $00h \leq c \leq \text{FFh}$

Function: Blink display action Blink pattern specified by "p".

Time is specified by "t1" and "t2"

A: $t1 \times \text{module timing unit}$ Normal display

B: $t2 \times \text{module timing unit}$ Blank or Reverse display (refer to 3.1 Timing Unit)

Repeated 'c' times.

This command does not affect Display Memory.

$c=00h$: Blink continues during subsequent command and data processing, until $c=01h\text{--}FFh$ is set, or Initialize command.

$c=01h\text{--}FFh$: Blink display is repeated 1–255 times while command and data processing is stopped. After display blinking is completed, Normal display returns and command and data processing resumes.

Command / data processing does not resume until operation is completed.

This command cannot be interrupted when running in a Macro.

4.7.4.24 US (a 12h v s p (Curtain display action)

Code: 1Fh 28h 61h 12h v s p

- v: Direction of Curtain action
- s: Curtain action speed
- p: Curtain action pattern

Definable area: $00h \leq v \leq 03h$

- v=00h: To the Right from the Left edge
- v=01h: To the Left from the Right edge.
- v=02h: To the Left and Right separately from the Center.
- v=03h: To the Center from Left edge and Right edge.

$00h \leq s \leq FFh$

$00h \leq p \leq FFh$

Function: Curtain display action on display screen

Curtain action pattern 'p' is displayed from the direction specified by 'v'.

Curtain action speed is:

Curtain action speed = $256 / 8 \times s \times$ module timing unit (refer to 3.1 Timing Unit)

This command only affects the display area. The non-display area memory is not affected.

Example is shown below.

Command / data processing does not resume until operation is completed.

If it is necessary to be able to cancel the display action during processing, this is possible if the command is defined and run in a Macro.

Example:

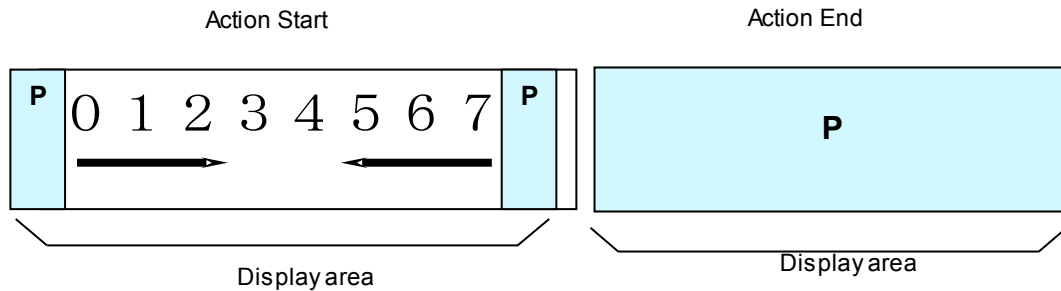

4.7.4.25 US (a 13h v s pL pH (Spring display action)

Code: 1Fh 28h 61h 13h v s pL pH

- v: Direction of spring action
- s: Spring action speed
- pL: Display Memory pattern address, lower byte
- pH: Display Memory pattern address, upper byte

Definable area: $00h \leq v \leq 03h$

- v=00h: To the Right from the Left edge.
- v=01h: To the Left from the Right edge.
- v=02h: To the Left and Right separately from the Center.
- v=03h: To the Center from Left edge and Right edge.

$00h \leq s \leq FFh$

$0000h \leq (pL + pH \times 100h) \leq \text{Max_DispMemAddr}$

Function: Spring display action on display screen.

Pattern 'p' specified by Display Memory pattern address is displayed from the direction specified by 'v'.

Spring action speed is as follows;

Spring action speed = $256 / 8 \times s \times$ module timing unit (refer to 3.1 Timing Unit)

This command effects only the display area, not hidden area.

Command / data processing does not resume until operation is completed.

If it is necessary to be able to cancel the display action during processing, this is possible if the command is defined and run in a Macro.

Example is shown below.

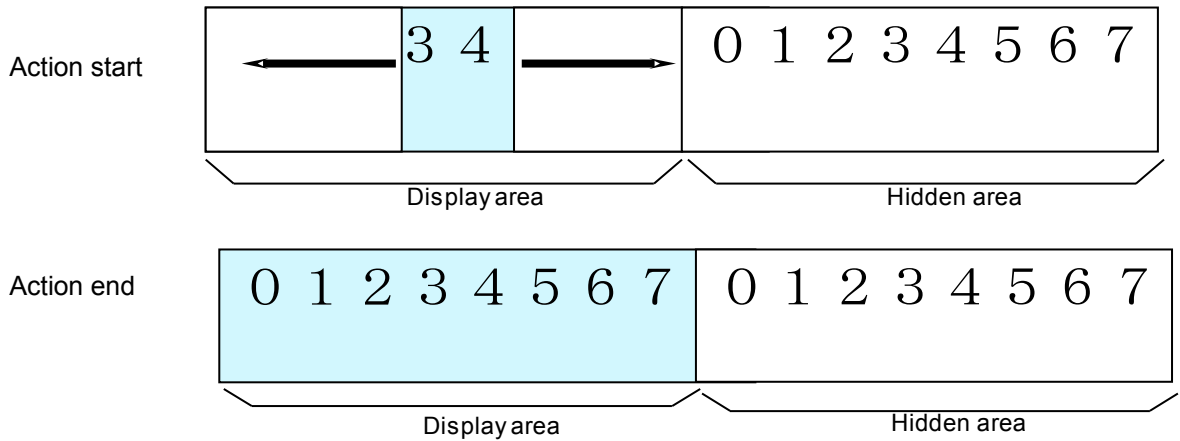

4.7.4.26 US (a 14h s pL pH (Random display action)

Code: 1Fh 28h 61h 14h s pL pH

- s: Random display action speed
- pL: Display Memory pattern address, lower byte
- pH: Display Memory pattern address, upper byte

Definable area: 00h ≤ s ≤ FFh
 0000h ≤ (pL + pH×100h) ≤ Max_DispmemAddr

Function: Random display action on display screen.

Pattern "p" specified by Display Memory pattern address is displayed randomly.

Random display action is completed in 8 steps, at approximately (s × 4 × module timing unit) / step.
 (Refer to 3.1 Timing Unit)

This command effects only the display area, not hidden area.

Command / data processing does not resume until operation is completed.

If it is necessary to be able to cancel the display action during processing, this is possible if the command is defined and run in a Macro.

Example is shown below.

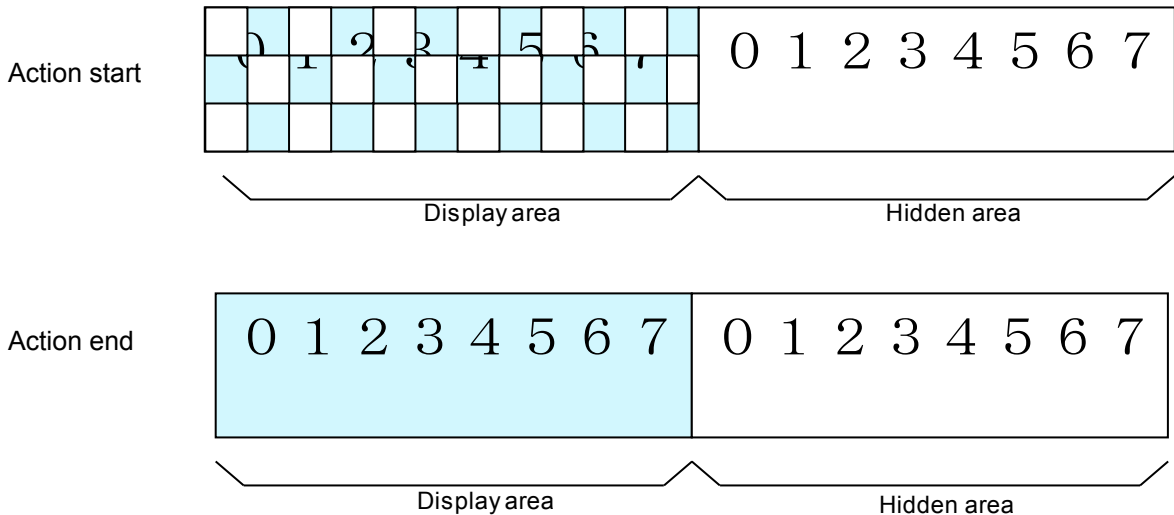

4.7.4.27 US (a 40h p (Display power ON/OFF/auto-OFF)**Code: 1Fh 28h 61h 40h p**

p: Set display power ON/OFF/auto-OFF

Definable area: p=00h: Power OFF (Display OFF, Power save mode)

p=01h: Power ON (Display ON)

p=10h: Power auto-OFF (Display ON → Display OFF, Power save mode)

Default: p = 01h

Function: Control display power ON / OFF / auto-OFF.

Display power ON/OFF setting applies until the next Display power or Initialize command, or power-off.

For display power auto-OFF, display power is ON, and is then turned OFF after Display power auto-OFF time. Regardless of the elapsed time, at the point of receiving any data, this mode is cancelled and display power is turned ON.

4.7.4.28 US (a 40h 11h t (Display power auto-OFF time)**Code: 1Fh 28h 61h 40h 11h t**

t: auto-OFF time

Definable area: 01h ≤ t ≤ FFh

Default: t = 1Eh (approximately 30 minutes)

Function: Set display power auto-OFF time.

auto-OFF time = t × 1 minute (±10%)

4.7.4.29 US (d 10h pen xL xH yL yH (Dot drawing)**Code: 1Fh 28h 64h 10h pen xL xH yL yH**

pen: Dot display ON or OFF

xL: Dot position x, lower byte

xH: Dot position x, upper byte

yL: Dot position y, lower byte

yH: Dot position y, upper byte

Definable area: 00h ≤ pen ≤ 01h

pen = 00h: Dot Display OFF, pen = 01h: Dot Display ON

0000h ≤ (xL + xH×100h) ≤ Max_Xdot

0000h ≤ (yL + yH×100h) ≤ Max_Ydot

Function: Display the dot at the position specified, or delete the dot already displayed.

This command has effect for the currently-selected window.

If Dot display ON/OFF, or Dot position is outside the definable area, the command is cancelled at that point and the following data is treated as standard data.

4.7.4.30 US (d 11h mode pen x1L x1H y1L y1H x2L x2H y2L y2H (Line/Box pattern drawing)**Code: 1Fh 28h 64h 11h mode pen x1L x1H y1L y1H x2L x2H y2L y2H**

mode: Line / Box / Box FILL select (refer to illustration)

pen: Line/Box Display ON or OFF

x1L: Line/Box pattern drawing start position x1, lower byte

x1H: Line/Box pattern drawing start position x1, upper byte

y1L: Line/Box pattern drawing start position y1, lower byte

y1H: Line/Box pattern drawing start position y1, upper byte

x2L: Line/Box pattern drawing end position x2, lower byte

x2H: Line/Box pattern drawing end position x2, upper byte

y2L: Line/Box pattern drawing end position y2, lower byte

y2H: Line/Box pattern drawing end position y2, upper byte

Definable area: 00h ≤ mode ≤ 02h

mode = 00h: Line

mode = 01h: Box

mode = 02h: Box FILL

00h ≤ pen ≤ 01h

pen = 00h: **Line/Box** Display OFF, pen = 01h: **Line/Box** Display ON

0000h ≤ (x1L + x1H×100h) ≤ Max_Xdot

0000h ≤ (y1L + y1H×100h) ≤ Max_Ydot

0000h ≤ (x2L + x2H×100h) ≤ Max_Xdot

0000h ≤ (y2L + y2H×100h) ≤ Max_Ydot

Function: Display a Line, Box, or Box FILL on the drawing area specified by (x1,y1)–(x2,y2) or delete the dot pattern already displayed.

This command has effect for the currently-selected window.

If Display ON/OFF or Dot pattern drawing position is outside the definable area, the command is cancelled at that point and the following data is treated as standard data.

If a diagonal line is specified, parts of the line may be 2 or more dots in width.

Drawing mode

Line Drawing

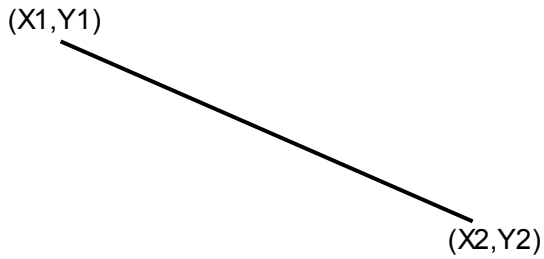

Box Drawing

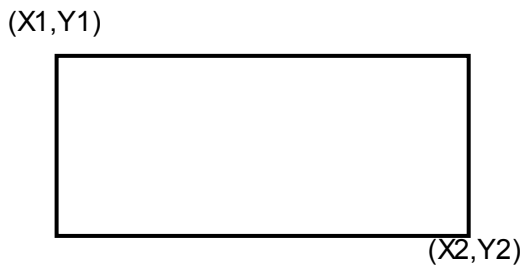

Box FILL Drawing

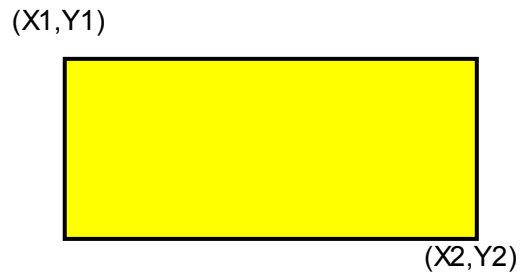

4.7.4.31 US (f 20h xPL xPH yPL yPH m aL aH aE ySL ySH xOL xOH yOL yOH xL xH yL yH g) (Dot unit downloaded bit image display)

Code: 1Fh 28h 64h 20h xPL xPH yPL yPH m aL aH aE ySL ySH xOL xOH yOL yOH xL xH yL yH g

xPL: Display position x, lower byte (by 1 dot)
 xPH: Display position x, upper byte (by 1 dot)
 yPL: Display position y, lower byte (by 1 dot)
 yPH: Display position y, upper byte (by 1 dot)
 m: Image data display memory select
 aL: Bit image data definition address, lower byte
 aH: Bit image data definition address, upper byte
 aE: Bit image data definition address, extension byte
 ySL: Bit image defined, Y size, lower byte (by 8 dots)
 ySH: Bit image defined, Y size, upper byte (by 8 dots)
 xOL: Image data offset x, lower byte (by 1 dot)
 xOH: Image data offset x, upper byte (by 1 dot)
 yOL: Image data offset y, lower byte (by 1 dot)
 yOH: Image data offset y, upper byte (by 1 dot)
 xL: Bit image display, X size, lower byte (by 1 dot)
 xH: Bit image display, X size, upper byte (by 1 dot)
 yL: Bit image display, Y size, lower byte (by 1 dot)
 yH: Bit image display, Y size, upper byte (by 1 dot)
 g: Image information = 01h (fixed)

Definable area: $0000h \leq (xPL + xPH \times 100h) \leq \text{Max_Xdot}$
 $0000h \leq (yPL + yPH \times 100h) \leq \text{Max_Ydot}$
 $00h \leq m \leq 02h$
 m = 00h: RAM bit image
 m = 01h: FROM bit image
 m = 02h: Display Memory bit image

RAM bit image:

$000000h \leq (aL + aH \times 100h + aE \times 10000h) \leq 000FFFh$

FROM bit image:

aE = 00h

$000000h \leq (aL + aH \times 100h + aE \times 10000h) \leq 007FFFh$

aE=01h – 04h (Extension area, 4 blocks)

$010000h \leq (aL + aH \times 100h + aE \times 10000h) \leq 04FFFFh$

Display Memory bit image:

$000000h \leq (aL + aH \times 100h + aE \times 10000h) \leq \text{Max_DispMemAddr}$

$0000h \leq (ySL + ySH \times 100h) \leq FFFFh$

$0000h \leq (xOL + xOH \times 100h) \leq FFFFh$

$0000h \leq (yOL + yOH \times 100h) \leq FFFFh$

$0001h \leq (xL + xH \times 100h) \leq \text{Xdots}$

$0001h \leq (yL + yH \times 100h) \leq \text{Ydots}$

g=01h

Function: Display the bit image defined in RAM or FROM at the specified (x,y) position.

Display position, display size, and image data offset are specified in units of 1 dot.

If bit image exceeds the bounds of the current window, only the portion within the currently-selected window is displayed.

If Display position or image size, etc are outside the definable area, the command is cancelled at the point where the error is detected, and the remaining data is treated as standard data.

Example:

Display position xP=2, xP=3
 Defined image data m=01h, a=001000h
 Defined image, Y size yS=0010h
 Offset xO=1, yO=3
 Display size x=9, y=12

FROM Bit Image memory

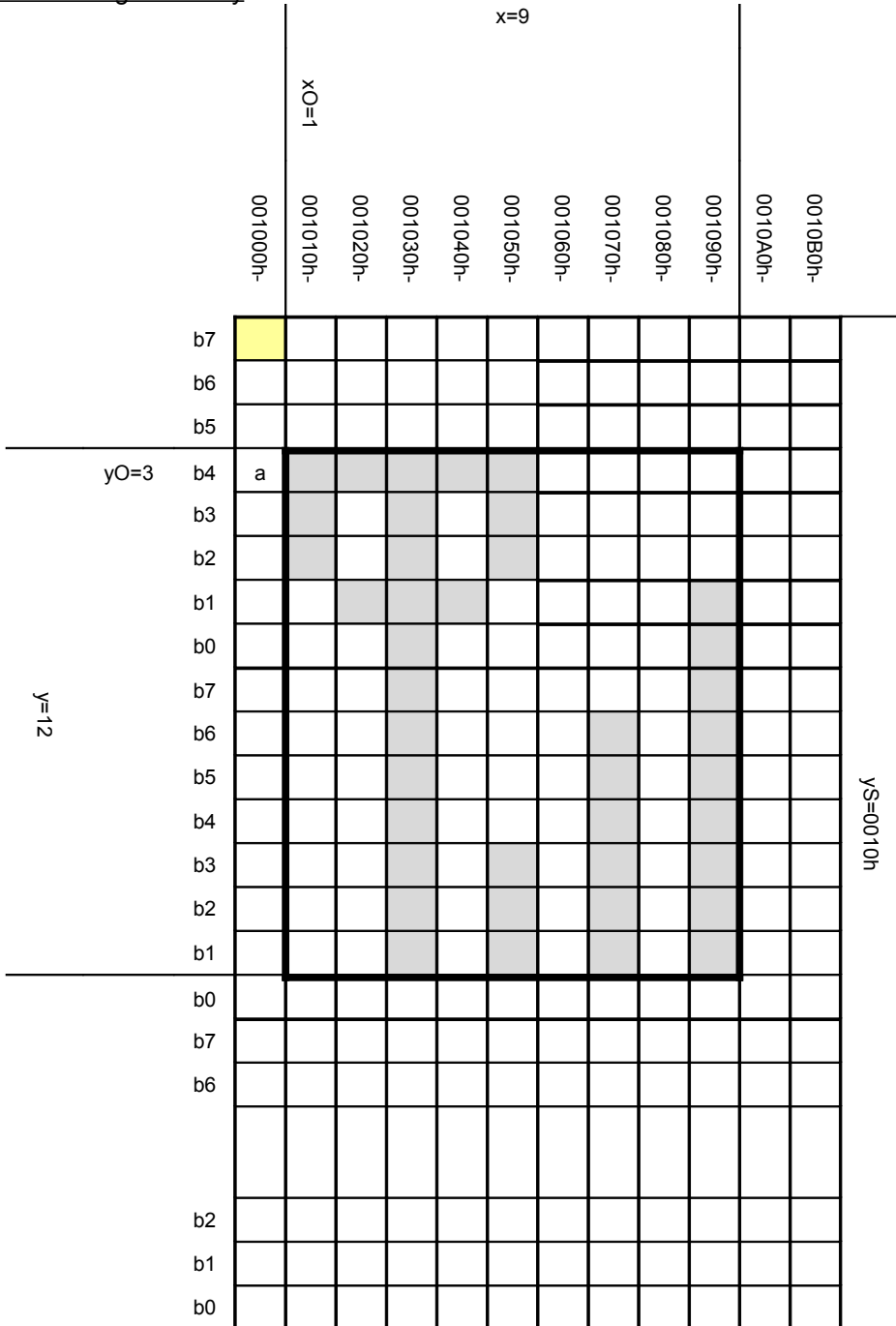

Display Memory

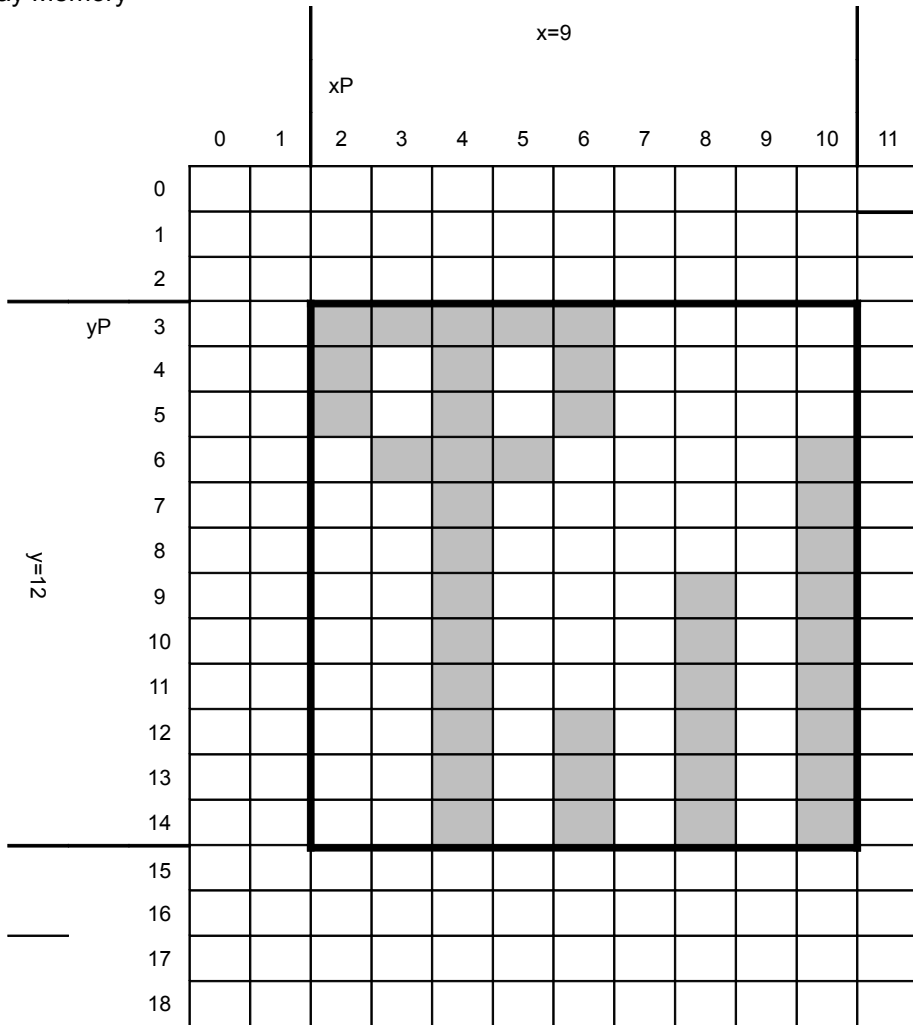

4.7.4.32 US (d 21h xPL xPH yPL yPH xL xH yL yH g d(1)...d(k) (Dot unit real-time bit image display)

Code: 1Fh 28h 64h 21h xPL xPH yPL yPH xL xH yL yH g d(1)...d(k)

- xPL: Display position x, lower byte (by 1 dot)
- xPH: Display position x, upper byte (by 1 dot)
- yPL: Display position y, lower byte (by 1 dot)
- yPH: Display position y, upper byte (by 1 dot)
- xL: Bit image display X size, lower byte (by 1 dot)
- xH: Bit image display X size, upper byte (by 1 dot)
- yL: Bit image display Y size, lower byte (by 1 dot)
- yH: Bit image display Y size, upper byte (by 1 dot)
- g: Display information = 1 (fixed)
- d(1)–d(k): Bit image data (see below)

Definable area: $0000h \leq (xPL + xPH \times 100h) \leq Max_Xdot$
 $0000h \leq (yPL + yPH \times 100h) \leq Max_Ydot$
 $0001h \leq (xL + xH \times 100h) \leq Xdots$
 $0001h \leq (yL + yH \times 100h) \leq Ydots$
 $g = 01h$
 $00h \leq d \leq FFh$

Function: Display the bit image data at the specified (x,y) position in real-time.

Display position and display size are specified in units of 1 dot.

If bit image exceeds the bounds of the current window, only the portion within the currently-selected window is displayed.

If Display position or display size are outside the definable area, the command is cancelled at the point where the error is detected, and the remaining data is treated as standard data.

Example: xP=2, yP=3, Display size x=8, y=14

Image data

| | | | | | | | | |
|----|----|----|----|----|-----|-----|-----|-----|
| b7 | d1 | d3 | d5 | d7 | d9 | d11 | d13 | d15 |
| b6 | | | | | | | | |
| b5 | | | | | | | | |
| b4 | | | | | | | | |
| b3 | | | | | | | | |
| b2 | | | | | | | | |
| b1 | | | | | | | | |
| b0 | | | | | | | | |
| b7 | d2 | d4 | d6 | d8 | d10 | d12 | d14 | d16 |
| b6 | | | | | | | | |
| b5 | | | | | | | | |
| b4 | | | | | | | | |
| b3 | | | | | | | | |
| b2 | | | | | | | | |
| b1 | | | | | | | | |
| b0 | | | | | | | | |

Display Memory

| | | x=8 | | | | | | | | | | | |
|----|----|-----|---|----|----|----|----|-----|-----|-----|-----|----|----|
| | | xP | | | | | | | | | | | |
| | | 0 | 1 | 2 | 3 | 4 | 5 | 6 | 7 | 8 | 9 | 10 | 11 |
| yP | 0 | | | | | | | | | | | | |
| | 1 | | | | | | | | | | | | |
| | 2 | | | | | | | | | | | | |
| | 3 | | | d1 | d3 | d5 | d7 | d9 | d11 | d13 | d15 | | |
| | 4 | | | | | | | | | | | | |
| | 5 | | | | | | | | | | | | |
| | 6 | | | | | | | | | | | | |
| | 7 | | | | | | | | | | | | |
| | 8 | | | | | | | | | | | | |
| | 9 | | | | | | | | | | | | |
| | 10 | | | | | | | | | | | | |
| | 11 | | | d2 | d4 | d6 | d8 | d10 | d12 | d14 | d16 | | |
| | 12 | | | | | | | | | | | | |
| | 13 | | | | | | | | | | | | |
| | 14 | | | | | | | | | | | | |
| | 15 | | | | | | | | | | | | |
| | 16 | | | | | | | | | | | | |
| | 17 | | | | | | | | | | | | |
| | 18 | | | | | | | | | | | | |

4.7.4.33 US (d 30h xPL xPH yPL yPH m bLen d(1)...d(bLen) (Dot unit character display)

Code: 1Fh 28h 64h 30h xPL xPH yPL yPH m bLen d(1)...d(bLen)

xPL: Display position x, lower byte (by 1 dot)

xPH: Display position x, upper byte (by 1 dot)

yPL: Display position y, lower byte (by 1 dot)

yPH: Display position y, upper byte (by 1 dot)

m: Response select

bLen: Character data length

d(1)–d(bLen): Character data / reverse select

Definable area: 0000h ≤ (xPL + xPH×100h) ≤ Max_Xdot, FFFFh

0000h ≤ (yPL + yPH×100h) ≤ Max_Ydot

00h ≤ m ≤ 01h

00h ≤ bLen ≤ FFh

00h ≤ d ≤ FFh

d=10h: Reverse OFF

d=11h: Reverse ON

Function: Display the specified text characters at the specified (x,y) position.

Display position is specified in units of 1 dot.

For display position xP=FFFFh, write position continues from previous writes done using this command.

The current settings for character size and table type, etc are used.

Character magnification and bold settings are not used.

If character display exceeds the bounds of the current window, only the portion within the currently-selected window is displayed.

If Display position or Response select is outside the definable area, the command is cancelled at the point where the error is detected, and the remaining data is treated as standard data.

Example: Display position xP=2, yP=3, 6×8 dot character "AB"

Display Memory

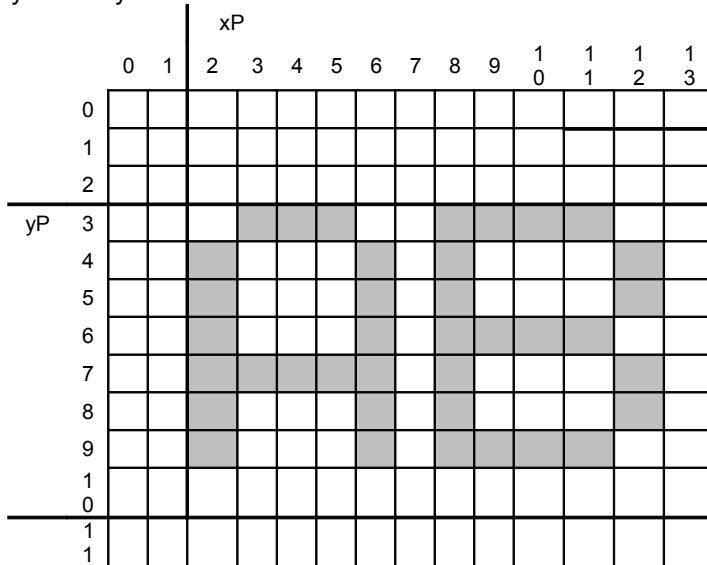

Response select m=01h: The display position of the next character is returned as response data.

If the display position would be 20 – 30 beyond the area of the currently-selected window, 0xFFFFh is returned.

| Transmitted data | Hex | Data length |
|------------------------------------|---------|-------------|
| (1) Header | 28h | 1 byte |
| (2) Identifier 1 | 64h | 1 byte |
| (3) Identifier 2 | 30h | 1 byte |
| (4) Display position X, lower byte | 00h–FFh | 1 byte |
| (5) Display position X, upper byte | 00h–FFh | 1 byte |

4.7.4.34 US (f 11h xL xH yL yH g d(1)...d(k) (Real-time bit image display)

Code: 1Fh 28h 66h 11h xL xH yL yH g d(1)...d(k)

- xL: Bit image X size, lower byte (by 1 dot)
- xH: Bit image X size, upper byte (by 1 dot)
- yL: Bit image Y size, lower byte (by 8 dots)
- yH: Bit image Y size, upper byte (by 8 dots)
- g: Image information = 1 (fixed)
- d(1)–d(k): Bit Image data (see below)

Definable area: $0001h \leq (xL + xH \times 100h) \leq Xdots$
 $0001h \leq (yL + yH \times 100h) \leq Ybytes$
 $g = 01h$
 $k = x \times y \times g$
 $00h \leq d \leq FFh$

Function: Display the bit image data at the cursor position in real-time.

Cursor position does not change.

If bit image exceeds the bounds of the current window, only the portion within the currently-selected window is displayed.

If Display position or display size etc, are outside the definable area, the command is cancelled at the point where the error is detected, and the remaining data is treated as standard data.

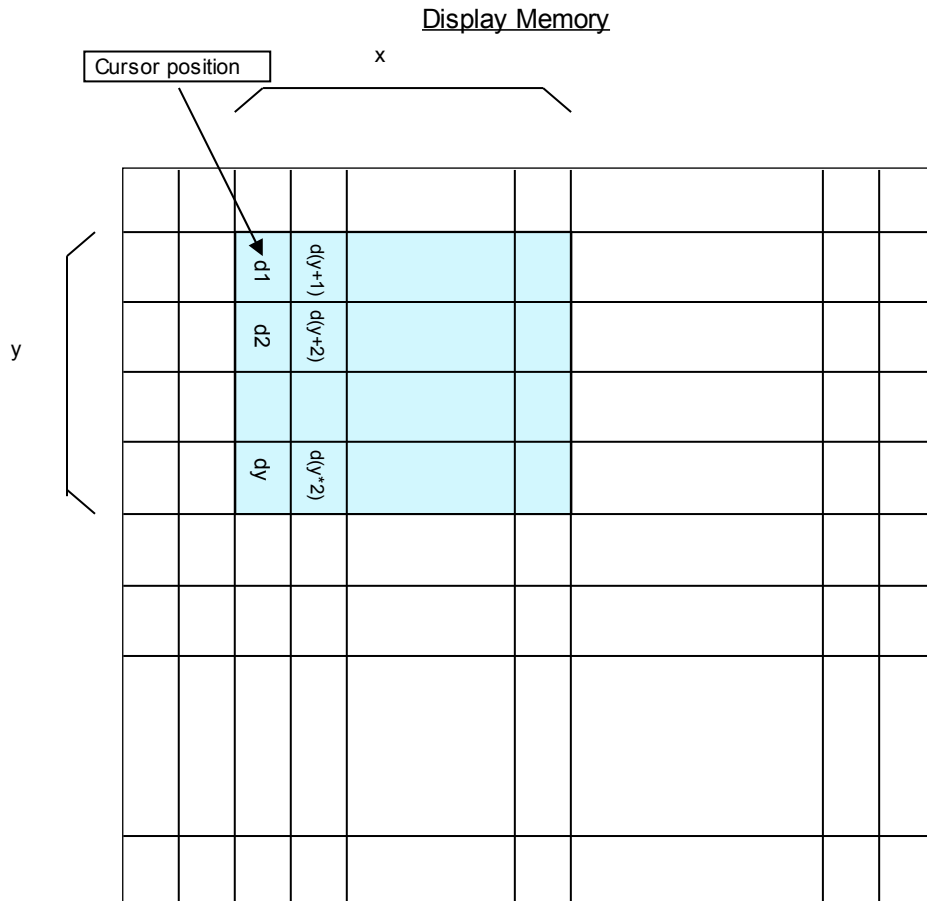

4.7.4.35 US (f 01h aL aH aE sL sH sE d(1)...d(s)) (RAM bit image definition)

Code: 1Fh 28h 66h 01h aL aH aE sL sH sE d(1)...d(s)

- aL: Bit image data definition address, lower byte
- aH: Bit image data definition address, upper byte
- aE: Bit image data definition address, extension byte
- sL: Bit image data length, lower byte
- sH: Bit image data length, upper byte
- sE: Bit image data length, extension byte
- d(1)–d(s): Image data (see below)

Definable area: $000000h \leq (aL + aH \times 100h + aE \times 10000h) \leq 000FFFh$
 $000001h \leq (sL + sH \times 100h + sE \times 10000h) \leq 001000h$
 $00h \leq d \leq FFh$

Function: Define user bit image to the RAM.

RAM bit image capacity is 4096 bytes.

Bit image data at arbitrary addresses can be defined or changed by appropriately setting Bit image data definition address and Bit image data length.

Bit images defined in RAM can be displayed using 4.7.4.37 Downloaded bit image display command. If Bit image data definition address or Bit image data length is outside the definable area, the command is cancelled at that point, and the remaining data is treated as standard data.

Example: RAM Bit image definition memory

Define 8 bytes data "0Ah,0Bh,0Ch,0Dh,0Eh,0Fh,10h,11h" from definition address "00000Ah"

(Code) 1Fh 28h 66h 01h 0Ah 00h 00h 08h 00h 00h 0Ah 0Bh 0Ch 0Dh 0Eh 0Fh 10h 11h

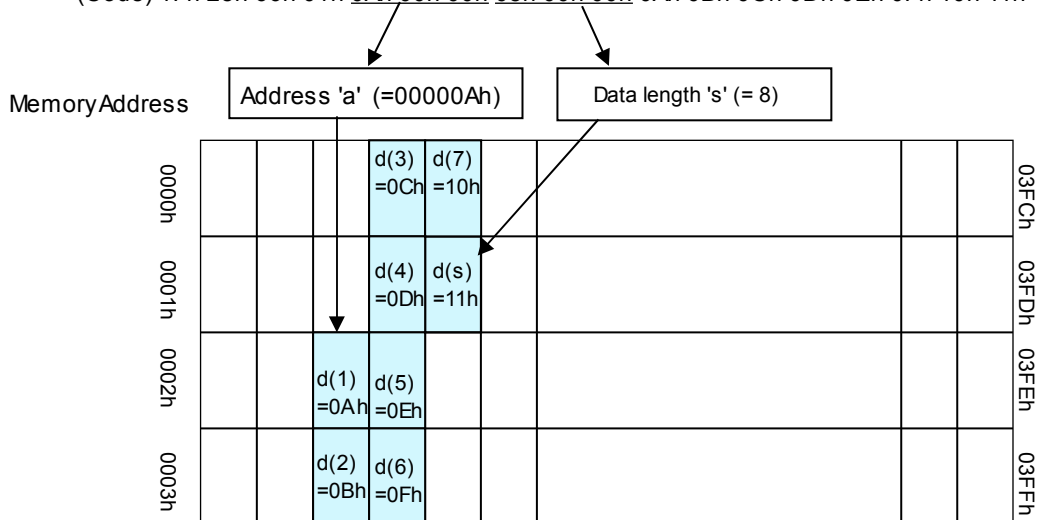

4.7.4.36 US (e 10h aL aH aE sL sH sE d(1)...d(s) (FROM bit image definition)**Code: 1Fh 28h 65h 10h aL aH aE sL sH sE d(1)...d(s)**

aL: Bit image data definition address, lower byte (bit 0 ignored)

aH: Bit image data definition address, upper byte

aE: Bit image data definition address, extension byte

sL: Bit image data length, lower byte (bit 0 ignored)

sH: Bit image data length, upper byte

sE: Bit image data length, extension byte

d(1)–d(s): Bit Image data (see below)

Definable area: aE = 00h – 04h

aE = 00h: $000000h \leq ((aL \& FEH) + aH \times 100h + aE \times 10000h) \leq 007FFEh$ $000002h \leq ((sL \& FEH) + sH \times 100h + sE \times 10000h) \leq 008000h$ **aE = 01h – 04h (Extension area, 4 blocks):** $010000h \leq ((aL \& FEH) + aH \times 100h + aE \times 10000h) \leq 04FFFEh$ $000002h \leq ((sL \& FEH) + sH \times 100h + sE \times 10000h) \leq 010000h$ $00h \leq d \leq FFh$

Function: Define user bit image to the FROM.

FROM bit image capacity is 32,768 bytes + Extension area 262,144 bytes.

Data is defined or changed from the specified Bit image data definition address for the number of bytes specified by Bit image data length.

Bit images defined in FROM can be displayed using 4.7.4.37 Downloaded bit image display command.

The least significant bit for both Bit image data definition address and Bit image data length is ignored – these are processed as even values.

If Bit image data definition address or Bit image data length is outside the definable area, the command is cancelled at that point, and the remaining data is treated as standard data.

This command is only valid in User setup mode.

BUSY signal is output by the display module during processing of this command. The host should not transmit any data during this time.

aE = 00h:

Total definable area is 000000h to 007FFFh (32,768 bytes). Bit image definition is performed in units of 2 bytes.

aE = 01h – 04h:

Total definable area is 010000h to 04FFFFh (262,144 bytes). Bit image definition is performed in units of 65536 bytes (64KB). For example, if 10KB of bit image data is defined, the remaining 54KB data is set to FFh.

Bit image data definition address cannot be specified in such a way that the definition data would overflow into the area of the next extension byte (for example, 01xxxxh – 02xxxxh). The command is cancelled if this situation is detected, and the remaining data is treated as standard data.

Defined contents are not guaranteed if an error occurs.

Example 1: FROM Bit image definition memory aE=00h area

Define 8 bytes data "0Ah,0Bh,0Ch,0Dh,0Eh,0Fh,10h,11h" from definition address "00000Ah"

(Code) 1Fh 28h 65h 10h 0Ah 00h 00h 08h 00h 00h 0Ah 0Bh 0Ch 0Dh 0Eh 0Fh 10h 11h

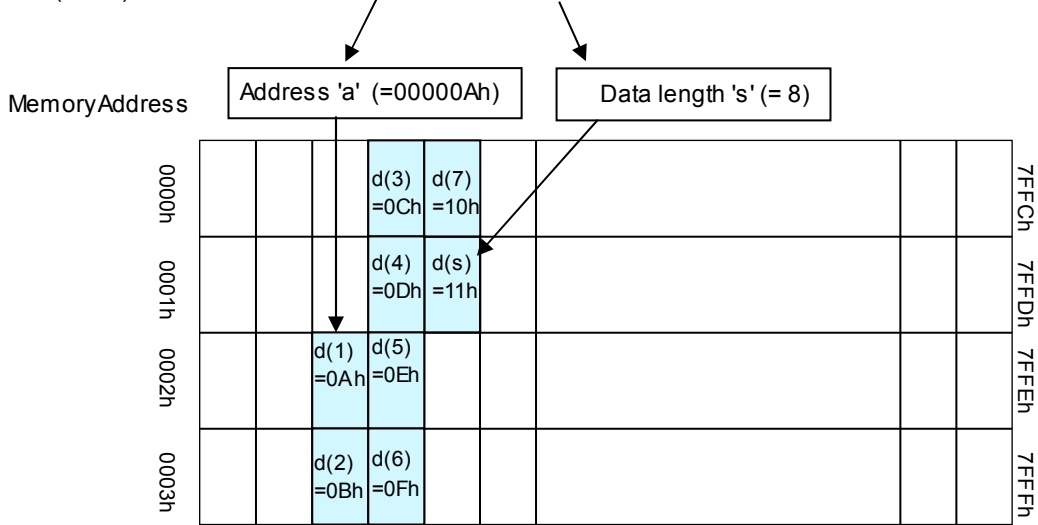

Example 2: FROM Bit image definition memory aE=01h area

Define 8 bytes data "0Ah,0Bh,0Ch,0Dh,0Eh,0Fh,10h,11h" from definition address "01000Ah"

(Code) 1Fh 28h 65h 10h 0Ah 00h 01h 08h 00h 00h 0Ah 0Bh 0Ch 0Dh 0Eh 0Fh 10h 11h

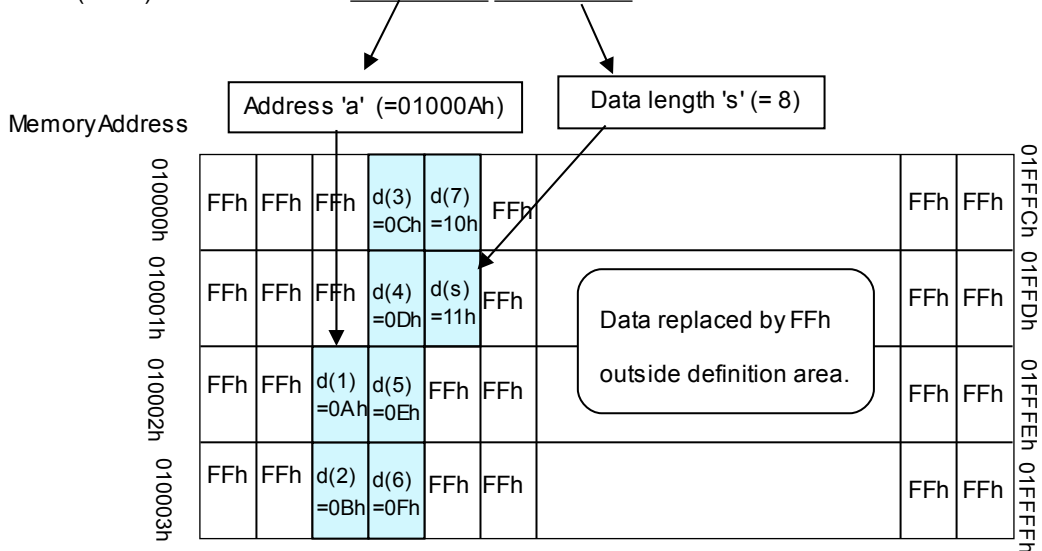

Note: Areas aE=02h – 04h are also processed as above.

4.7.4.37 US (f 10h m aL aH aE ySL ySH xL xH yL yH g) (Downloaded bit image display)**Code: 1Fh 28h 66h 10h m aL aH aE ySL ySH xL xH yL yH g**

m: Select bit image data memory
 aL: Bit image data definition address, lower byte
 aH: Bit image data definition address, upper byte
 aE: Bit image data definition address, extension byte
 ySL: Bit image defined Y size, lower byte (by 8 dots)
 ySH: Bit image defined Y size, upper byte (by 8 dots)
 xL: Bit image display X size, lower byte (by 1 dot)
 xH: Bit image display X size, upper byte (by 1 dot)
 yL: Bit image display Y size, lower byte (by 8 dots)
 yH: Bit image display Y size, upper byte (by 8 dots)
 g: Image information = 1 (fixed)

Definable area: $00h \leq m \leq 02h$

m = 00h: RAM bit image
 m = 01h: FROM bit image
 m = 02h: Display Memory bit image

RAM bit image: $000000h \leq (aL + aH \times 100h + aE \times 10000h) \leq 000FFFh$ **FROM bit image:****aE = 00h** $000000h \leq (aL + aH \times 100h + aE \times 10000h) \leq 007FFFh$ **aE=01h – 04h (Extension area, 4 blocks)** $010000h \leq (aL + aH \times 100h + aE \times 10000h) \leq 04FFFFh$ **Display Memory bit image:** $000000h \leq (aL + aH \times 100h + aE \times 10000h) \leq \text{Max_DispMemAddr}$ $0000h \leq (ySL + ySH \times 100h) \leq FFFFh$ $0001h \leq (xL + xH \times 100h) \leq \text{Xdots}$ $0001h \leq (yL + yH \times 100h) \leq \text{Ybytes}$

g = 01h

Function: Display, at the cursor position, the bit image defined in RAM, FROM, or in Display Memory.

Cursor position does not change.

Select RAM, FROM or Display Memory bit image by Select Bit image data memory 'm'.

Set Bit image defined Y size to the same Y size of the bit image defined in memory.

A portion of the Defined bit image can be displayed by setting Bit image display Y size less than Defined bit image Y size, or by changing Bit image display X size and/or Bit image data definition address.

If the bit image extends beyond the currently-selected window, only the portion within the current window is displayed.

When the bit image is being written to the Display Memory, if the bit image memory area is exceeded, undefined data is displayed.

Note for aE = 01h – 04h:

Bit image data can be read from 010000h to 04FFFFh continuously (bit image display can cross a block boundary).

Bit image memory (RAM, FROM, or Display Memory)

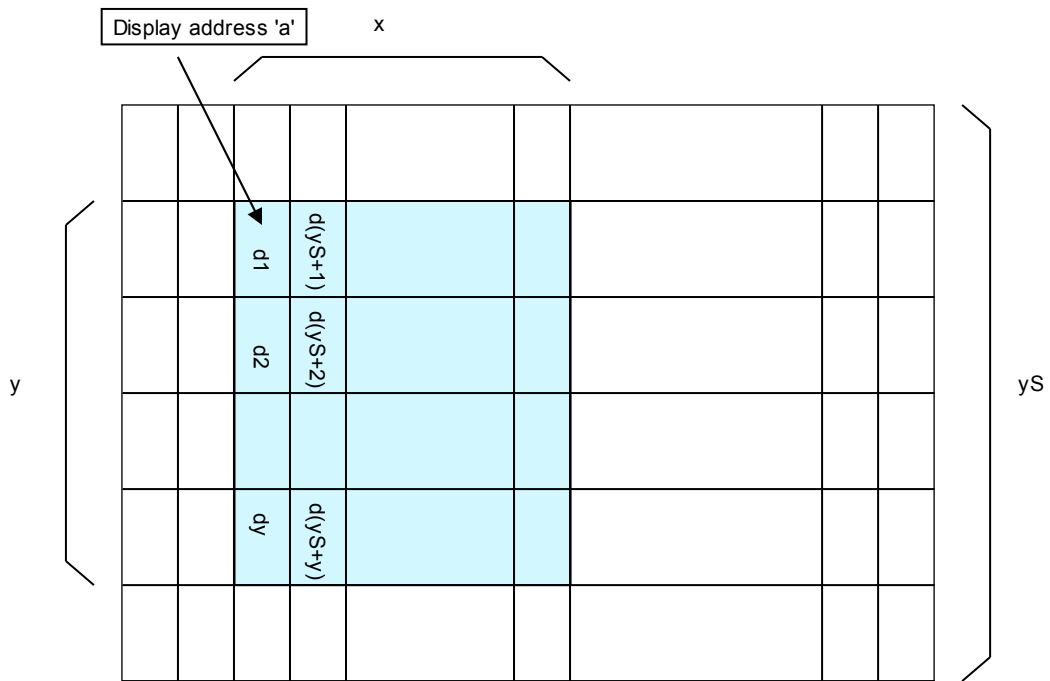

Bit image data write

Display Memory

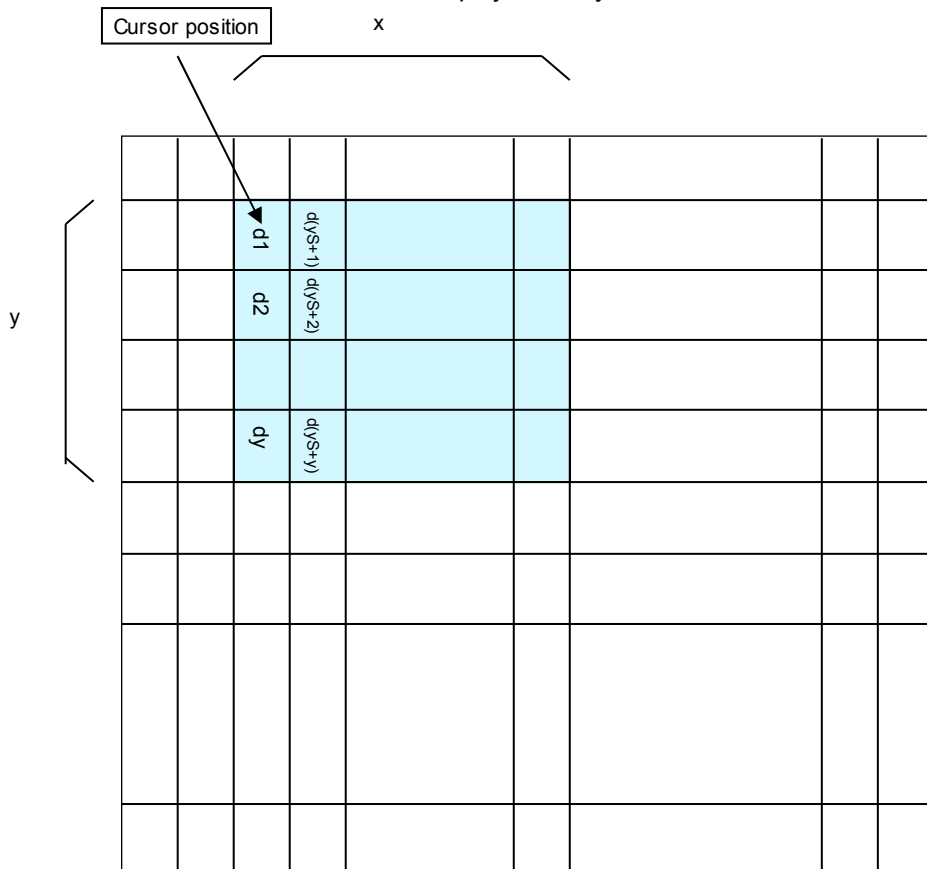

4.7.4.38 US (f 90h m aL aH aE ySL ySH xL xH yL yH g s) (Downloaded bit image scroll display)

Code: 1Fh 28h 66h 90h m aL aH aE ySL ySH xL xH yL yH g s

- m: Select bit image data memory
- aL: Bit image data definition address, lower byte
- aH: Bit image data definition address, upper byte
- aE: Bit image data definition address, extension byte
- ySL: Bit image defined Y size, lower byte (by 8 dots)
- ySH: Bit image defined Y size, upper byte (by 8 dots)
- xL: Bit image scroll display shift X size, lower byte (by 1 dot)
- xH: Bit image scroll display shift X size, upper byte (by 1 dot)
- yL: Bit image scroll display Y size, lower byte (by 8 dots)
- yH: Bit image scroll display Y size, upper byte (by 8 dots)
- g: Image information = 1 (fixed)
- s: Scroll speed select

Definable area: 00h ≤ m ≤ 01h

- m = 00h: RAM bit image
- m = 01h: FROM bit image

RAM bit image:

$$000000h \leq (aL + aH \times 100h + aE \times 10000h) \leq 000FFFh$$

FROM bit image:

aE = 00h

$$000000h \leq (aL + aH \times 100h + aE \times 10000h) \leq 007FFFh$$

aE = 01h – 04h (Extension area, 4 blocks)

$$010000h \leq (aL + aH \times 100h + aE \times 10000h) \leq 04FFFFh$$

$$0000h \leq (ySL + ySH \times 100h) \leq FFFFh$$

$$0001h \leq (xL + xH \times 100h) \leq FFFFh$$

$$0001h \leq (yL + yH \times 100h) \leq Ybytes$$

g = 01h

s = 00h – 1Fh

| s | Scroll speed |
|-----------|------------------------------------|
| 00h | 4 dots / module timing unit |
| 01h | 2 dots / module timing unit |
| 02h – 1Fh | 1 dot / (s-1) × module timing unit |

Function: Scroll display, from the right end of current window, at cursor height, the bit image defined in RAM or FROM.

Cursor position does not change.

Select RAM or FROM bit image by Select Bit image data memory 'm'.

Set Bit image defined Y size to the same Y size of the bit image defined in memory.

A portion of the Defined bit image can be displayed by setting Bit image scroll display Y size less than Defined bit image Y size, or by changing Bit image data definition address.

Note for aE = 01h – 04h:

Bit image data can be read from 010000h to 04FFFFh continuously (bit image display can cross a block boundary).

If the bit image memory area 010000 – 04FFFF is exceeded, undefined data is displayed.

Note: Scroll speed is approximate. Depending on the scrolling area, scroll may reduce in speed or flicker. See also 4.7.4.39 Horizontal scroll display quality select and 3.1 Timing Unit.

Bit image memory (RAM or FROM)

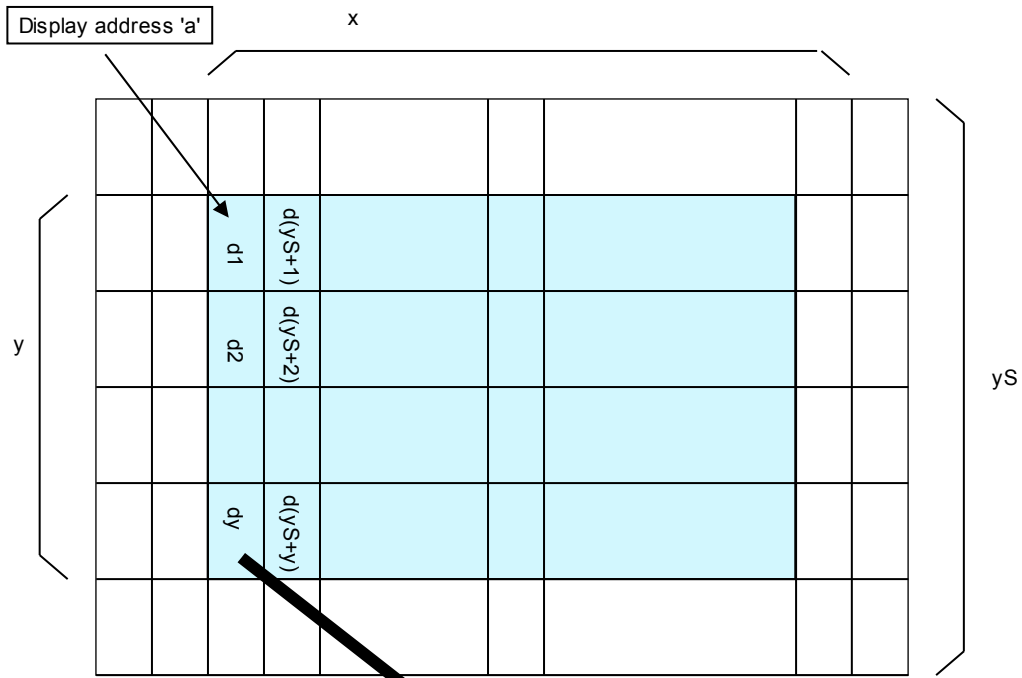

Write bit image data from the right end of current window at cursor height. (Scroll display)

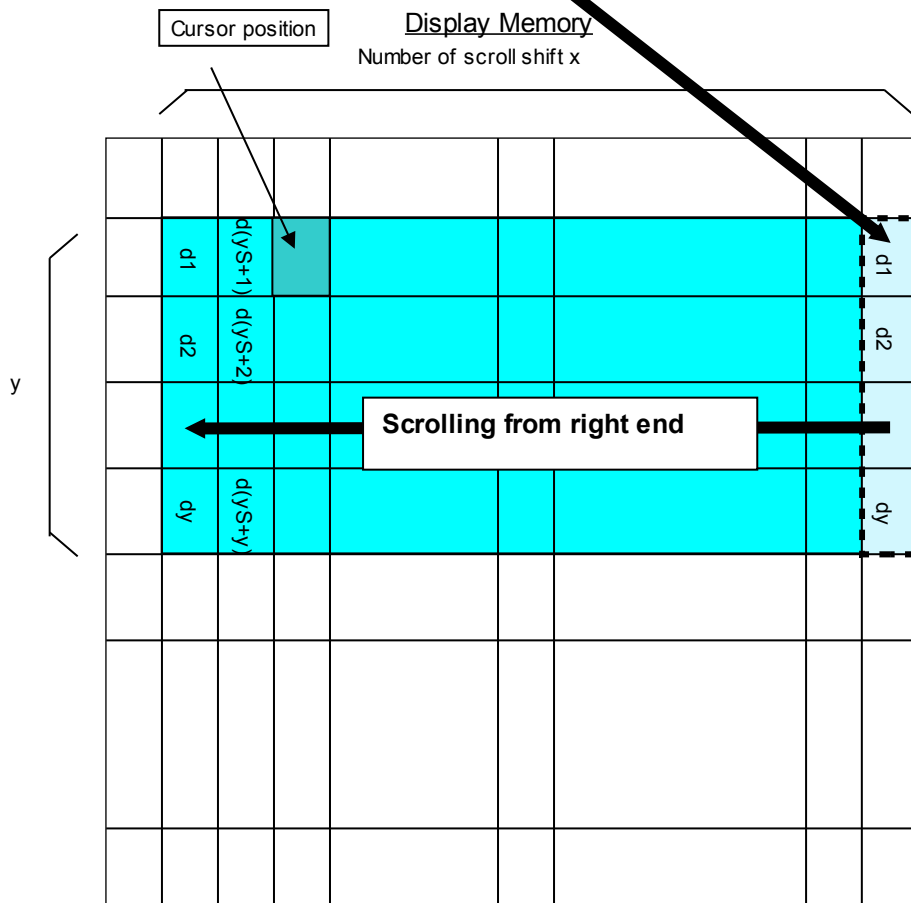

4.7.4.39 US m n (Horizontal scroll display quality select)

Code: 1Fh 6Dh n

n: Horizontal scroll display quality

Definable area: $00h \leq n \leq 01h$

n = 00h: Scroll speed-priority

n = 01h: Visual quality-priority

Default: n = 00h or Memory SW setting.

Function: Select horizontal scroll display quality – Scroll speed-priority or Visual quality-priority.

If Scroll speed-priority is selected, scroll speed will be faster, but partial display flickering may increase.

If Visual quality-priority is selected, partial display flickering will decrease, but scroll speed may become slower.

Applicable for Character display and Horizontal Tab command in Horizontal scroll mode, and Downloaded bit image scroll display.

4.7.4.40 US r n (Reverse display)

Code: 1Fh 72h n

n: Reverse display ON/OFF

Definable area: $00h \leq n \leq 01h$

n = 00h: Reverse OFF

n = 01h: Reverse ON

Default: n = 00h or Memory SW setting.

Function: Reverse display ON/OFF for character and image display.

Changing this setting only affects subsequent data. Content already displayed is not affected.

4.7.4.41 US w n (Write mixture display mode)

Code: 1Fh 77h n

n: Display write mode

Definable area: $00h \leq n \leq 03h$

n = 00h: Normal display write (not mixture display)

n = 01h: OR display write

n = 02h: AND display write

n = 03h: EX-OR display write

Default: n = 00h or Memory SW setting.

Function: Specifies write mixture mode.

Newly-written characters and images are combined with current display contents in Display Memory.

4.7.4.42 US (w 01h a (Window select)

Code: 1Fh 28h 77h 01h a

a: Window number

a = 00h: Base-Window

a = 01h – 04h: User-Window

Definable area: $00h \leq a \leq 04h$

Function: Select current window.

Command is ignored if Window number is for a User-Window that is not defined.

4.7.4.43 US (w 02h a b[xPL xPH yPL yPH xSL xSH ySL ySH] (User Window define / cancel)

Code: 1Fh 28h 77h 02h a b [xPL xPH yPL yPH xSL xSH ySL ySH]

- a: Definable window No. No. 1 – 4
- b: Define or Cancel b = 00h: Cancel, b = 01h: Define
- xPL: Left position of window x, lower byte (by 1 dot)
- xPH: Left position of window x, upper byte (by 1 dot)
- yPL: Top position of window y, lower byte (by 8 dot)
- yPH: Top position of window y, upper byte (by 8 dot)
- xSL: X size of window, lower byte (by 1 dot)
- xSH: X size of window, upper byte (by 1 dot)
- ySL: Y size of window, lower byte (by 8 dot)
- ySH: Y size of window, upper byte (by 8 dot)

Definable area: $01h \leq a \leq 04h$
 $00h \leq b \leq 01h$
 $0000h \leq (xPL + xPH \times 100h) \leq \text{Max_Xdot}$
 $0000h \leq (yPL + yPH \times 100h) \leq \text{Max_Ybyte}$
 $0001h \leq (xSL + xSH \times 100h) \leq (\text{Xdots} - (xPL + xPH \times 100h))$
 $0001h \leq (ySL + ySH \times 100h) \leq (\text{Ybytes} - (yPL + yPH \times 100h))$

Function: Define or cancel User-Window
 Display contents are not changed by this command.

User-Window define (b=01h):

Specify User-Window number, window position, and window size. Window position and Window size are specified in units of one block (1×8 dot).

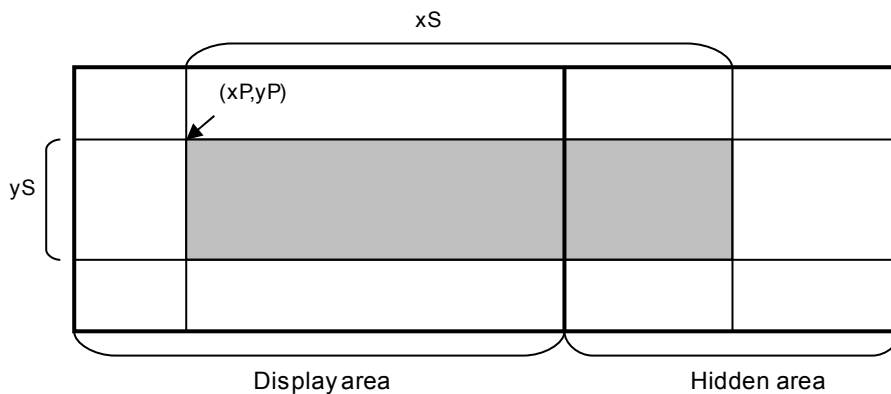

Up to 4 User-Windows can be defined.
 The cursor position for the window is initialized to top left (X=0, Y=0).

User-Window cancel (b=00h):

For User-Window cancel, window range parameters [xPL – ySH] are not used.
 If the currently-selected window is cancelled, the Base-Window becomes the currently-selected window.

If any of 'a', 'b', 'xP', 'yP', 'xS', or 'yS' are outside the definable area, the command is cancelled at that point and the following data is treated as standard data.

4.7.4.44 ESC % n (Download character ON/OFF)**Code: 1Bh 25h n**

Function: Enable or disable display of download characters (6×8, 8×16, 12×24, and 16×32 dot).

n = 01h: Enable (If download character is not defined, built-in character is displayed)

n = 00h: Disable

Characters already displayed are not affected.

4.7.4.45 ESC & a c1 c2 [x1 d1...d(y×x1)]...[xk d1...d(y×xk)] (Download character definition)**Code: 1Bh 26h a c1 c2 [x1 d1...d(y×x1)]...[xk d1...d(y×xk)]**

a: Select character type

c1: Start character code

c2: End character code

x: Number of dots for X-direction

d: Definition data (refer to 4.9 Download character format)

Definable area: 01h ≤ a ≤ 04h

a = 01h: 6×8 dot character

00h ≤ x ≤ 06h

a = 02h: 8×16 dot character

00h ≤ x ≤ 08h

a = 03h: 12×24 dot character

00h ≤ x ≤ 0Ch

a = 04h: 16×32 dot character

00h ≤ x ≤ 10h

20h ≤ c1 ≤ c2 ≤ FFh

00h ≤ d ≤ FFh

k = c2 - c1 + 1

Function: Define download characters (1-byte characters) into RAM.

For each font size, a maximum of 16 download characters can be defined.

After the maximum number of download characters are defined, in order to define other character codes, space must first be obtained using the Download character delete command.

Downloaded characters are valid until redefined, an initialize (ESC@) sequence is executed, or the power is turned off.

To display download characters the commands Download character definition and Download character ON/OFF (set to ON) are required.

If x is smaller than the character width, the remaining space on the right is filled with blank (non-display) dots.

If a currently-displayed download character is re-defined, there is no affect on the currently-displayed character. It is effective only for newly input characters.

Download characters can be saved into FROM using the Save download character command.

4.7.4.46 ESC ? a c (Download character delete)**Code: 1Bh 3Fh a c**

a: Select character type

c: Delete Character code

Definable area: 01h ≤ a ≤ 04h

a = 01h: 6×8 dot character

a = 02h: 8×16 dot character

a = 03h: 12×24 dot character

a = 04h: 16×32 dot character

20h ≤ c ≤ FFh

Function: Delete defined download character (1-byte character).

Built-in character is displayed after download character is deleted.

Characters already displayed are not affected.

Command is ignored if download character is not defined for the given character code.

4.7.4.47 US (g 10h c1 c2 d1...d32 (16×16 Download character definition)

Code: 1Fh 28h 67h 10h c1 c2 d1...d32

- c1: Character code, upper byte
- c2: Character code, lower byte
- d: Definition data (refer to 4.9 Download character format)

Definable area: c1, c2: Depends on language:

| Language | Encoding | c1 | c2 |
|---------------------|--------------------------|----------|----------------|
| Japanese | JIS X0208 (SHIFT-JIS) | c1 = ECh | 40h ≤ c2 ≤ 4Fh |
| Korean | KSC5601-87 | c1 = FEh | A1h ≤ c2 ≤ B0h |
| Simplified Chinese | GB2312-80 | c1 = FEh | A1h ≤ c2 ≤ B0h |
| Traditional Chinese | Big-5 | c1 = FEh | A1h ≤ c2 ≤ B0h |

00h ≤ d ≤ FFh

Function: Defines a 16×16 dot downloaded character (2-byte character) in character code specified by c1 and c2. A maximum of 16 download characters can be defined.

Definition data "d" is processed as character pattern data in column format, and is stored sequentially from the left.

Download character is temporary stored in RAM, but can be stored in FROM using Download character save command.

4.7.4.48 US (g 11h c1 c2 (16×16 Downloaded character delete)

Code: 1Fh 28h 67h 11h c1 c2

- c1: Character code, upper byte
- c2: Character code, lower byte

Definable area: c1, c2: Depends on language:

| Language | Encoding | c1 | c2 |
|---------------------|--------------------------|----------|----------------|
| Japanese | JIS X0208 (SHIFT-JIS) | c1 = ECh | 40h ≤ c2 ≤ 4Fh |
| Korean | KSC5601-87 | c1 = FEh | A1h ≤ c2 ≤ B0h |
| Simplified Chinese | GB2312-80 | c1 = FEh | A1h ≤ c2 ≤ B0h |
| Traditional Chinese | Big-5 | c1 = FEh | A1h ≤ c2 ≤ B0h |

Function: Delete defined 16×16 dot download character in code specified by c1 and c2.

4.7.4.49 US (g 14h c1 c2 d1...d128 (32×32 Download character definition)

Code: 1Fh 28h 67h 14h c1 c2 d1...d128

- c1: Character code, upper byte
- c2: Character code, lower byte
- d: Definition data (refer to 4.9 Download character format)

Definable area: c1, c2: Depends on language:

| Language | Encoding | c1 | c2 |
|----------|--------------------------|----------|----------------|
| Japanese | JIS X0208 (SHIFT-JIS) | c1 = ECh | 40h ≤ c2 ≤ 4Fh |

00h ≤ d ≤ FFh

Function: Defines a 32×32 dot downloaded character (2-byte character) in character code specified by c1 and c2. A maximum of 16 download characters can be defined.

Definition data "d" is processed as character pattern data in column format, and is stored sequentially from the left.

Download character is temporary stored in RAM, but can be stored in FROM using Download character save command.

This command is invalid if language selection is not set to Japanese.

4.7.4.50 US (g 15h c1 c2 (32×32 Downloaded character delete)

Code: 1Fh 28h 67h 15h c1 c2

c1: Character code, upper byte

c2: Character code, lower byte

Definable area: c1, c2: Depends on language:

| Language | Encoding | c1 | c2 |
|----------|--------------------------|----------|-----------------|
| Japanese | JIS X0208 (SHIFT-JIS) | c1 = ECh | 40h ≤ c2 ≤ 4Fh, |

Function: Delete defined 32×32 dot download character in code specified by c1 and c2.

This command is invalid if language selection is not set to Japanese.

4.7.4.51 US (e 11h a (Download character save)

Code: 1Fh 28h 65h 11h a

a: Font size

Definable area: 01h ≤ a ≤ 06h

a=01h: 6×8 dot

a=02h: 8×16 dot

a=03h: 16×16 dot

a=04h: 16×32 dot

a=05h: 32×32 dot

a=06h: 12×24 dot

Function: Save the download characters defined on RAM to FROM (RAM→FROM).

The saved content is re-enabled using the Download character restore command.

This command is only valid in User setup mode.

BUSY signal is output by the display module during processing of this command. The host should not transmit any data during this time.

4.7.4.52 US (e 21h a (Download character restore)

Code: 1Fh 28h 65h 21h a

a: Font size

Definable area: 01h ≤ a ≤ 06h

a=01h: 6×8 dot

a=02h: 8×16 dot

a=03h: 16×16 dot

a=04h: 16×32 dot

a=05h: 32×32 dot

a=06h: 12×24 dot

Function: Transfer the download characters saved in FROM to RAM (FROM→RAM).

Command is ignored if specified font size download characters are not registered in FROM.

Command is valid in both User setup mode and Normal mode.

4.7.4.53 US (e 13h m P(80h-1) P(80h-2)...P(FFh-n) (FROM User font definition)

Code: 1Fh 28h 65h 13h m P(80h-1) P(80h-2)...P(FFh-n)

m: User table
p: Definition data (refer to Download character format)

Definable area: m = 01h, 02h, 03h, 04h
m = 01h: 6×8 dot
m = 02h: 8×16 dot
m = 03h: 12×24 dot
m = 04h: 16×32 dot

00h ≤ P ≤ FFh

m=01h: P(80h-1).....P(80h-6).....P(FFh-6) 6 Bytes / font × 128 characters (768 bytes)
m=02h: P(80h-1).....P(80h-16).....P(FFh-16) 16 Bytes / font × 128 characters (2,048 bytes)
m=03h: P(80h-1).....P(80h-36).....P(FFh-36) 36 Bytes / font × 128 characters (4,068 bytes)
m=04h: P(80h-1).....P(80h-64).....P(FFh-64) 64 Bytes / font × 128 characters (8,192 bytes)

Function: Define the user font for each size of 1-byte code to the user table.

This command defines all 128 characters at once; it is not possible to only define a part of the character code space.

User font tables for each font size are set to blank (00h) when shipped.

This command is only valid in User setup mode.

4.7.4.54 US (e 15h a b p(1)...p(65536) (FROM extension font definition)

Code: 1Fh 28h 65h 15h a b p(1)...p(65536)

a: Bank
b: Define / Delete
p: Definition data (if Define)

Definable area: a = 01h
b = 00h, 01h
00h ≤ p ≤ FFh

Function: Define or delete FROM extension font.

b=00h: FROM extension font is deleted. Definition data parameter is not used.

b=01h: FROM extension font is defined. Consult manufacturer for definition data format. FROM extension font is in deleted state when shipped.

This command is only valid in User setup mode.

4.7.4.55 US (e 01h d1 d2 (User setup mode start)

Code: 1Fh 28h 65h 01h 49h 4Eh

Definable area: d1 = 49h (Character 'I')
d2 = 4Eh (Character 'N')

Function: Start User setup mode.

The following response data is sent from the RS-232 interface:

| Transmitted data | Hex | Data length |
|------------------|-----|-------------|
| (1) Header | 28h | 1 byte |
| (2) Identifier 1 | 65h | 1 byte |
| (3) Identifier 2 | 01h | 1 byte |
| (4) NUL | 00h | 1 byte |

This command is only valid in Normal mode. Display screen is blanked.

4.7.4.56 US (e 02h d1 d2 d3 (User setup mode end)

Code: 1Fh 28h 65h 02h 4Fh 55h 54h

Definable area: d1 = 4Fh (Character 'O')
d2 = 55h (Character 'U')
d3 = 54h (Character 'T')

Function: End User setup mode, and software reset of display as follows:

- (1) Wait for any in-progress operations (memory control, information transmission, etc) to complete.
- (2) Output display BUSY signal.
- (3) Software reset.

This command is only valid in User setup mode.

This command clears the receive buffer, and all settings (Download character, Macro settings, etc) are reset to power-on state.

4.7.4.57 US (p 01h n a (I/O Port Input / Output setting)

Code: 1Fh 28h 70h 01h n a
 n: I/O port number
 a: Set Input / Output (bit-wise)

Definable area: 00h ≤ n ≤ 01h
 n = 00h: Port 0
 n = 01h: Port 1
 00h ≤ a ≤ FFh
 Bit value = 0: Input
 Bit value = 1: Output

Function: Set input or output for general-purpose I/O ports.
 Port input / output is set by value of 'a'. Bit assignment is as follows:

| | | | | | | | | |
|--------------|------|------|------|------|------|------|------|------|
| Port bit No. | Bit7 | Bit6 | Bit5 | Bit4 | Bit3 | Bit2 | Bit1 | Bit0 |
| Data bit | D7 | D6 | D5 | D4 | D3 | D2 | D1 | D0 |

Caution: I/O port is intended for simple peripheral switches and for controlling lights, etc, and should not be used for applications where high reliability is required.

4.7.4.58 US (p 10h n a (I/O Port Output)

Code: 1Fh 28h 70h 10h n a
 n: I/O port number
 a: Output data value

Definable area: 00h ≤ n ≤ 01h
 n = 00h: Port 0
 n = 01h: Port 1
 00h ≤ a ≤ FFh

Function: Output data to general-purpose I/O port.
 Output data is set by value of 'a'. Bit assignment is as follows:

| | | | | | | | | |
|--------------|------|------|------|------|------|------|------|------|
| Port bit No. | Bit7 | Bit6 | Bit5 | Bit4 | Bit3 | Bit2 | Bit1 | Bit0 |
| Data bit | D7 | D6 | D5 | D4 | D3 | D2 | D1 | D0 |

4.7.4.59 US (p 20h n (I/O Port Input)

Code: 1Fh 28h 70h 20h n
 n: I/O port number

Definable area: 00h ≤ n ≤ 01h
 n = 00h: Port 0
 n = 01h: Port 1

Function: The state of a general-purpose I/O port at the time this command is processed is transmitted.

The following data is transmitted from the RS-232 interface:

| Transmitted data | Hex | Data length |
|--------------------|---------|-------------|
| (1) Header | 28h | 1 byte |
| (2) Identifier (1) | 70h | 1 byte |
| (3) Identifier (2) | 20h | 1 byte |
| (4) Data | 00h-FFh | 1 byte |

Response time varies depending on the state of the receive buffer.

4.7.4.60 US : pL pH [d1...dk] (RAM Macro define / delete)**Code: 1Fh 3Ah pL pH [d1...dk]**

pL: RAM Macro data length, lower byte
 pH: RAM Macro data length, upper byte
 d: RAM Macro data

Definable area: $0000h \leq (pL + pH \times 100h) \leq 4000h$

Function: Define or delete RAM Macro or RAM Program Macro.

 $(pL + pH \times 100h) > 0000h$: Supplied data "d" is stored as Macro. $(pL + pH \times 100h) = 0000h$: Macro is deleted.

If Macro data length is outside the definable area, the command is cancelled, and the following data is treated as standard data.

Do not define any of the following commands in a Macro:

Initialize, Macro execution, RAM Macro define / delete, User setup mode start, [US (e) group commands (FROM bit image definition, Download character save, etc), Macro execution settings, Memory re-write mode.

Program Macro details: Refer to specification DS-1600-0006-XX Program Macro.**4.7.4.61 US (e 12h a pL pH t1 t2 [d(1)...d(p)] (FROM Macro define / delete)****Code: 1Fh 28h 65h 12h a pL pH t1 t2 [d1...d(p)]**

a: FROM Macro registration number
 pL: FROM Macro data length, lower byte
 pH: FROM Macro data length, upper byte
 t1: Display time interval ($t1 \times$ module timing unit)
 t2: Idle time for Macro repetition ($t2 \times$ module timing unit) (refer to 3.1 Timing Unit)
 d: FROM Macro data

Definable area: $01h \leq a \leq 04h$: FROM Macro number 1 – 4 $0000h \leq (pL + pH \times 100h) \leq 1000h$ (if using 4 Macros), $4000h$ (if using 1 Macro) $00h \leq t1 \leq FFh$ $00h \leq t2 \leq FFh$ $00h \leq d \leq FFh$

Function: Define or delete FROM Macro or FROM Program Macro.

FROM Macro storage capacity is a total of 16KB, 4KB / Macro when using 4 Macros.

For Macros exceeding 4KB, multiple Macro definition areas are used, which may result in some Macro number areas being undefined.

 $(pL + pH \times 256) > 0$: Supplied data "d" is stored as Macro. $(pL + pH \times 256) = 0$: Macro is deleted.

If Macro data length is outside the definable area, the command is cancelled, and the following data is treated as standard data.

Display time interval (t1) and Idle time (t2) settings are used when FROM Macro execution at power-on is used.

Display time interval refers to the interval time between displaying characters, and does not affect the processing speed of command code.

Idle time refers to the time period from processing the last Macro data until the Macro is re-executed.

This command is only valid in User setup mode.

Do not define any of the following commands in a Macro:

Initialize, Macro execution, RAM Macro define / delete, User setup mode start, [US (e) group commands (FROM bit image definition, Download character save, etc), Macro execution settings, Memory re-write mode.

BUSY signal is output by the display module during processing of this command. The host should not transmit any data during this time.

Program Macro details: Refer to specification DS-1600-0006-XX Program Macro.

Example:

| | |
|-------------------|-----------|
| FROM Macro 1 area | Undefined |
| FROM Macro 2 area | Undefined |
| FROM Macro 3 area | Undefined |
| FROM Macro 4 area | Undefined |

↓ Define 4KB Macros in Macro 1 – 4

| | |
|-------------------|------------------|
| FROM Macro 1 area | FROM Macro 1 4KB |
| FROM Macro 2 area | FROM Macro 2 4KB |
| FROM Macro 3 area | FROM Macro 3 4KB |
| FROM Macro 4 area | FROM Macro 4 4KB |

↓ Define 8KB Macro in Macro 2

| | |
|-------------------|------------------|
| FROM Macro 1 area | FROM Macro 1 4KB |
| FROM Macro 2 area | FROM Macro 2 8KB |
| FROM Macro 3 area | |
| FROM Macro 4 area | FROM Macro 4 4KB |

↓ Define 8KB Macro in Macro 3

| | |
|-------------------|------------------|
| FROM Macro 1 area | FROM Macro 1 4KB |
| FROM Macro 2 area | Undefined |
| FROM Macro 3 area | FROM Macro 3 8KB |
| FROM Macro 4 area | |

↓ Define 12KB Macro in Macro 1

| | |
|-------------------|-------------------|
| FROM Macro 1 area | FROM Macro 1 12KB |
| FROM Macro 2 area | |
| FROM Macro 3 area | |
| FROM Macro 4 area | Undefined |

4.7.4.62 US ^ n t1 t2 (Macro execution)

Code: 1Fh 5Eh a t1 t2

- a: Macro processing definition number
- t1: Display time interval (t1 × module timing unit)
- t2: Idle time for Macro repetition (t2 × module timing unit) (refer to 3.1 Timing Unit)

Definable area: 00h ≤ a ≤ 04h, 80h ≤ a ≤ 84h

- a = 00h: RAM Macro 0
- 01h ≤ a ≤ 04h: FROM Macro 1 – 4
- a = 80h: RAM Program Macro 0
- 81h ≤ a ≤ 84h: FROM Program Macro 1 – 4

00h ≤ t1 ≤ FFh
00h ≤ t2 ≤ FFh

Function: Continuously execute contents of defined Macro 'a'.

Display time interval refers to the interval time between displaying characters, and does not affect the processing speed of command code.

Idle time refers to the time period from processing the last Macro data until the Macro is re-executed.

If Macro 'a' is not defined, or is outside the definable area, the entire command (up to t2) is ignored.

Macro execution is stopped when a command is input. The current window (Write screen mode area if Base-Window) is cleared and cursor moves to home position. Display settings remain in the current state when the Macro ended.

4.7.4.63 US (i 20h a b c (Macro end condition)**Code: 1Fh 28h 69h 20h a b c**

a: Macro end code Enable/Disable
 b: Macro end code
 c: Macro end Clear Screen setting

Definable area: a = 00h, 01h

a = 00h: Macro end code Disabled

a = 01h: Macro end code Enabled

00h ≤ b ≤ FFh

c = 00h, 01h

c = 00h: Clear Screen at Macro end

c = 01h: Do not clear screen at Macro end

Default: a = 00h or Memory SW setting.

b = 00h or Memory SW setting.

c = 00h or Memory SW setting.

Function: Macro end condition set.

a = 00h: Macro will unconditionally end if data is received.

a = 01h: Macro will end if data byte 'b' is received. All other values are ignored.

c = 00h: Clear screen on Macro end.

c = 01h: Do not clear screen on Macro end.

The received byte code that ends the Macro is processed as the first byte of the next command.

This setting is not applicable for Program Macro.

4.7.4.64 US (e 03h a b (Memory SW setting)**Code: 1Fh 28h 65h 03h a b****1Fh 28h 65h 03h a b c[1] d[1] [... c[b] d[b]]**

a: Memory SW Number

b: Setting data

Definable area: Set Memory SW:

00h ≤ a ≤ 3Fh

00h ≤ b ≤ FFh

Multiple Memory SW setting:

a = FFh

01h ≤ b ≤ FFh

00h ≤ c ≤ 3Fh

00h ≤ d ≤ FFh

Function: Set Memory SW.

A single Memory switch can be set (a=00h–3Fh) or multiple Memory switches can be set (a=FFh).

Single setting (a=00h–3Fh): a = Memory SW number, b = Setting value.

Multiple setting (a=FFh): b = Number of settings, c = Memory SW number, d = Setting value.

This command is only valid in User setup mode.

BUSY signal is output by the display module during processing of this command. The host should not transmit any data during this time.

Memory SW details: Refer to section 6.2 Memory SW (MSW).

4.7.4.65 US (e 04h a (Memory SW data send)

**Code: 1Fh 28h 65h 04h a
1Fh 28h 65h 04h a b c[1] [... c[b]]**

a: Memory SW Number

Definable area: Single read:
00h ≤ a ≤ 3Fh
Multiple read:
a = FFh
01h ≤ b ≤ FFh
00h ≤ c ≤ 3Fh

Function: Send the contents of Memory SW data.

A single Memory switch can be read (a=00h–3Fh) or multiple Memory switches can be read (a=FFh).

Single read (a=00h–3Fh): a = Memory SW number.

Multiple read (a=FFh): b = Number of reads, c = Memory SW number.

The following data is transmitted from the RS-232 interface:

| Transmitted data | Hex | Data length |
|------------------|---------|--------------------|
| (1) Header | 28h | 1 byte |
| (2) Identifier 1 | 65h | 1 byte |
| (3) Identifier 2 | 04h | 1 byte |
| (4) Data | 00h–FFh | 1 byte / b byte(s) |

This command is valid in both User setup mode and Normal mode.

Memory SW details: Refer to section 6.2 Memory SW (MSW).

4.7.4.66 US (e 18h sL sH sE m1 a1L a1H a1E d[1]...d[s] (General-purpose memory store)

Code: 1Fh 28h 65h 18h sL sH sE m1 a1L a1H a1E d[1] ... d[s]

sL: Data size, lower byte
sH: Data size, upper byte
sE: Data size, extension byte
m1: Memory select
a1L: Memory address, lower byte
a1H: Memory address, upper byte
a1E: Memory address, extension byte
d: Data to store

Definable area: m1 = 30h (General-purpose RAM):
000001h ≤ (sL + sH×100h + sE×10000h) ≤ 000400h
000000h ≤ (a1L + a1H×100h + a1E×10000h) ≤ 0003FFh
m1 = 31h (General-purpose FROM):
000001h ≤ (sL + sH×100h + sE×10000h) ≤ 001000h
000000h ≤ (a1L + a1H×100h + a1E×10000h) ≤ 00FFFFh

Note: General-purpose FROM is in units of 001000h, with a total of 16 areas.

Function: Store the supplied data into general-purpose memory.

Stored data can be read using General-purpose memory send command or by Program Macro.

Storage that would exceed the address range cannot be set.

For General-purpose RAM, data is stored only into the specified address range.

For General-purpose FROM, data is stored into the specified address range, and all other memory locations in the same FROM area are set to FFh. Further, it is not possible to specify data storage that would exceed a general-purpose FROM area.

This command is valid in both User setup mode and Normal mode.

4.7.4.67 US (e 19h sL sH sE m1 a1L a1H a1E m2 a2L a2H a2E (General-purpose memory transfer)

Code: 1Fh 28h 65h 19h sL sH sE m1 a1L a1H a1E m2 a2L a2H a2E

- sL: Transfer size, lower byte
- sH: Transfer size, upper byte
- sE: Transfer size, extension byte
- m1: Destination memory select
- a1L: Destination address, lower byte
- a1H: Destination address, upper byte
- a1E: Destination address, extension byte
- m2: Source memory select
- a2L: Source address, lower byte
- a2H: Source address, upper byte
- a2E: Source address, extension byte

Definable area: m1, m2 = 30h (General-purpose RAM):
 $000001h \leq (sL + sH \times 100h + sE \times 10000h) \leq 000400h$
 $000000h \leq (a1L + a1H \times 100h + a1E \times 10000h) \leq 0003FFh$
 $000000h \leq (a2L + a2H \times 100h + a2E \times 10000h) \leq 0003FFh$
 m1, m2 = 31h (General-purpose FROM):
 $000001h \leq (sL + sH \times 100h + sE \times 10000h) \leq 001000h$
 $000000h \leq (a1L + a1H \times 100h + a1E \times 10000h) \leq 00FFFFh$
 $000000h \leq (a2L + a2H \times 100h + a2E \times 10000h) \leq 00FFFFh$

Note: General-purpose FROM is in units of 001000h, with a total of 16 areas.

Function: Transfer data between general-purpose memory areas.

Storage that would exceed the address range cannot be set.

For General-purpose RAM, data is transferred only into the specified address range.

For General-purpose FROM, data is transferred into the specified address range, and all other memory locations in the same FROM area are set to FFh. Further, it is not possible to specify data transfer that would exceed a general-purpose FROM area.

Operation is not guaranteed if source and destination areas overlap.

This command is valid in both User setup mode and Normal mode.

4.7.4.68 US (e 28h sL sH sE m1 a1L a1H a1E (General-purpose memory send)

Code: 1Fh 28h 65h 28h sL sH sE m1 a1L a1H a1E

- sL: Data size, lower byte
- sH: Data size, upper byte
- sE: Data size, extension byte
- m1: Memory select
- a1L: Memory address, lower byte
- a1H: Memory address, upper byte
- a1E: Memory address, extension byte

Definable area: m1 = 30h (General-purpose RAM):
 $000001h \leq (sL + sH \times 100h + sE \times 10000h) \leq 000400h$
 $000000h \leq (a1L + a1H \times 100h + a1E \times 10000h) \leq 0003FFh$
 m1 = 31h (General-purpose FROM):
 $000001h \leq (sL + sH \times 100h + sE \times 10000h) \leq 001000h$
 $000000h \leq (a1L + a1H \times 100h + a1E \times 10000h) \leq 00FFFFh$

Note: General-purpose FROM is in units of 001000h, with a total of 16 areas.

Function: Send data stored in general-purpose memory.

Data read that would exceed the address range cannot be set.

This command is valid in both User setup mode and Normal mode.

The following data is transmitted from the RS-232 interface:

| Transmitted data | Hex | Data length |
|------------------|---------|-------------|
| (1) Header | 28h | 1 byte |
| (2) Identifier 1 | 65h | 1 byte |
| (3) Identifier 2 | 28h | 1 byte |
| (4) Data | 00h-FFh | s byte(s) |

4.7.4.69 US (e 40h a [b c] (Display status send)

Code: 1Fh 28h 65h 40h a [b c]

Definable area: a = 01h: Boot version information (b, c not used)
 a = 02h: Firmware version information (b, c not used)
 a = 10h: 2-byte character code information (b, c not used)
 a = 11h: Language type information (b, c not used)
 a = 20h: Memory checksum information
 00h ≤ b ≤ FFh: Start address (Effective address = b×10000h)
 00h ≤ c ≤ FFh: Data length (Effective data length = c×10000h)
 a = 30h: Product type information (b, c not used)
 a = 40h: Display x dot information (b, c not used)
 a = 41h: Display y dot information (b, c not used)

Function: Send display status information.

The following data is transmitted from the RS-232 interface:

| Transmitted data | Hex | Data length |
|------------------|---------|---|
| (1) Header | 28h | 1 byte |
| (2) Identifier 1 | 65h | 1 byte |
| (3) Identifier 2 | 40h | 1 byte |
| (4) Data | 00h-FFh | a = 01h: 4 bytes a = 02h: 4 bytes a = 10h: 15 bytes a = 11h: 15 bytes a = 20h: 4 bytes a = 30h: 15 bytes a = 40h: 3 bytes a = 41h: 3 bytes |

This command is valid in both User setup mode and Normal mode.

4.7.4.70 US (i 10h a b (RS-232 serial settings)

Code: 1Fh 28h 69h 10h a b

a: Baud rate setting
 b: Parity setting

Definable area: 00h ≤ a ≤ 0Bh
 a=00h: 19200 bps
 a=01h: 4800 bps
 a=02h: 9600 bps
 a=03h: 19200 bps
 a=04h: 38400 bps
 a=05h: 57600 bps
 a=06h: 115200 bps
 07h ≤ a ≤ 0Bh: Setting prohibited
 00h ≤ b ≤ 02h
 b=00h: No parity
 b=01h: Even parity
 b=02h: Odd parity

Function: Change the RS-232 serial interface communication parameters.

Operation is [DTR=MARK][Communication settings change][DTR=SPACE], so do not send the next data until DTR=SPACE.

If unsent data is in the transmit buffer (due to DSR=MARK), this data may not be transmitted correctly, so ensure the transmit buffer is clear before issuing this command.

For baud rate setting a = 07h – 0Bh, display operation is not guaranteed. Do not use this setting.

4.7.4.71 FS | M m d1...d6 (Memory re-write mode)

Code: 1Ch 7Ch 4Dh m d1 ... d6

Definable area: m = D0h
 d1...d6 = "MODEIN"

Function: Shift to "Memory re-write mode" from "Normal mode".

Memory re-write mode is used for changing the firmware and fonts, etc in FROM that cannot be changed in User setup mode.

Changing this FROM requires special commands and tools.

Do not use this command.

4.8 Bit image data format

The Bit image consists of data for image size (x × y) as follows:

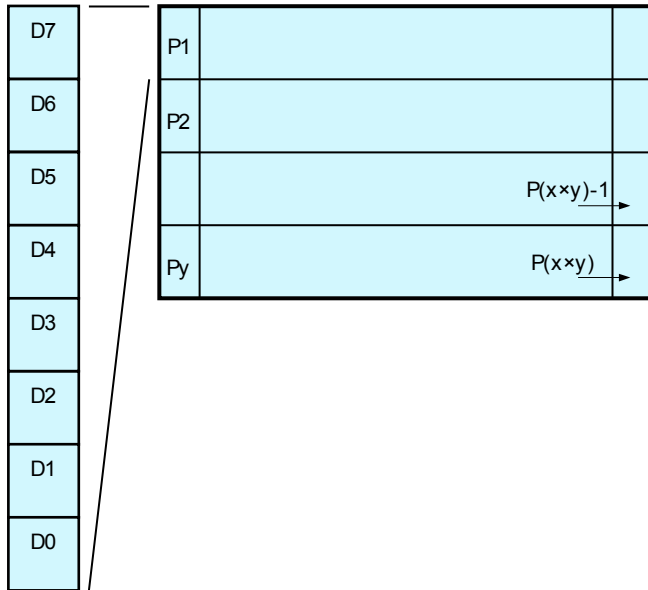

| Data | Pattern position |
|-----------|------------------|
| d (1) | P1 |
| d (2) | P2 |
| | |
| d (x × y) | P(x × y) |

4.9 Download character format

Download character format is shown below.

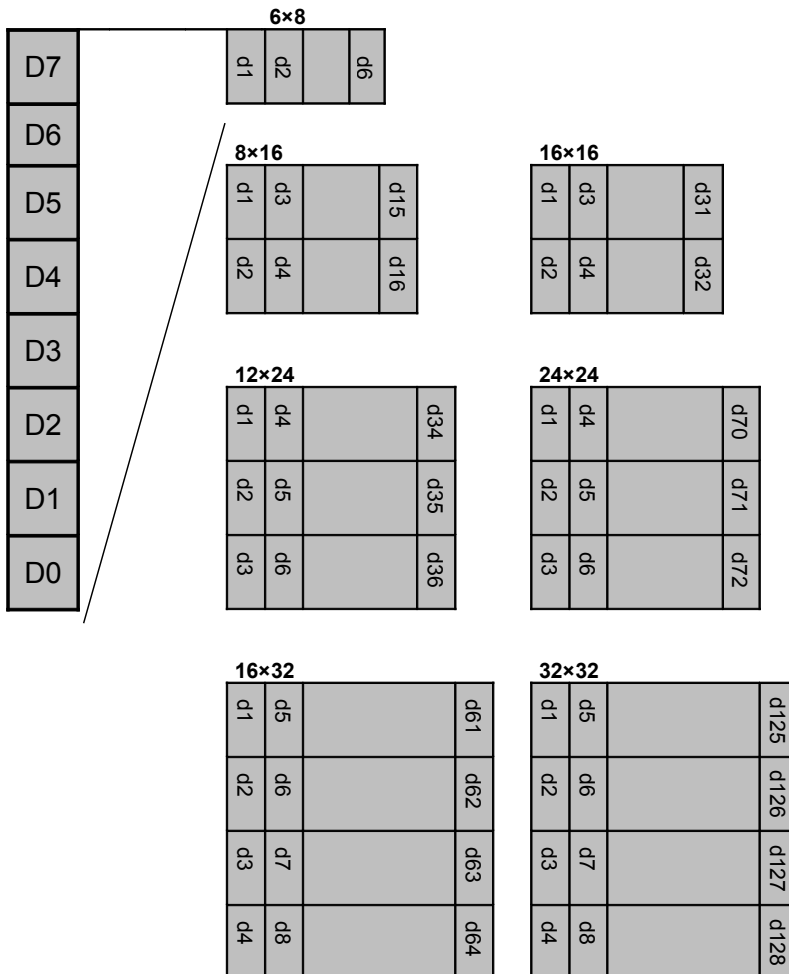

5 Graphic DMA mode (Applicable for Parallel interface only)

5.1 Displayable image types

5.1.1 Graphic display

Depends on model – refer to 3 VFD Module model-specific information.

5.2 Display Memory

Size: Refer to 3.2 Display Memory configuration.

The portion of memory which is displayed is selected using the “Display start address” command. Display Memory is a roll configuration. In areas of the display screen that would exceed the Display Memory, the contents from 0000h are displayed.

Example for 256×64 dot module:

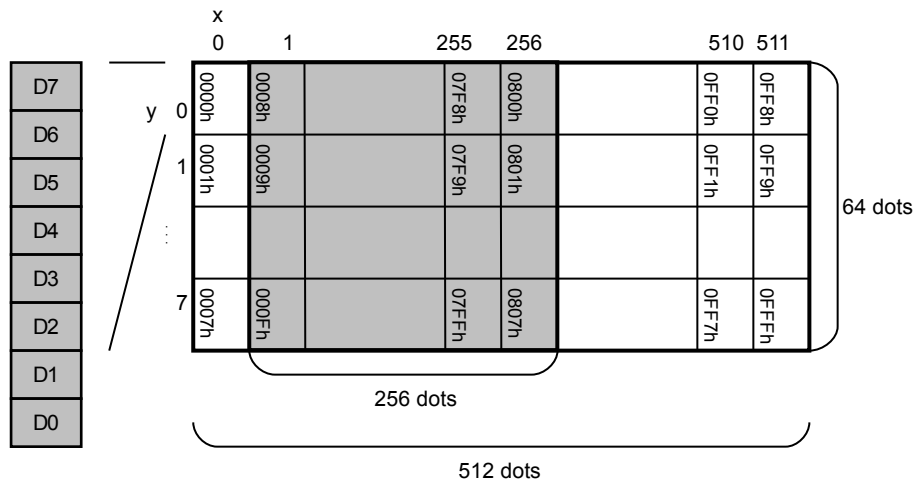

5.3 Protocol

High-speed graphic display is possible by using the parallel interface for data input. The Graphic DMA mode protocol is described below.

Display waits until a valid “Header (STX)” + “Header 2” combination is received. The module only processes packets with an address that matches the display's address set by DIP-SW + MSW. Using this mode, a maximum of 255 displays, addressed by DIP-SW and MSW settings, can be controlled individually.

Packets addressed to FFh are processed by all connected displays.

| Header 1 | Header 2 | Address | Command/Data |
|-----------|----------|-----------|--------------|
| STX (02h) | 44h | 00h – FFh | 00h – FFh |
| 1 byte | 1 byte | 1 byte | n byte(s) |

5.4 Commands

| Command Name | Hex Code | Operation | Page |
|--------------------------|---|--|------|
| Bit image write | 02h,44h,DAD,46h, aL,aH,sL,sH, d(1)...d(s) | Write bit image data to the specified address. DAD: Display address aL: Bit image write address, lower byte aH: Bit image write address, upper byte sL: Bit image write size, lower byte sH: Bit image write size, upper byte d(1)...d(s): Bit image data | p65 |
| BOX Area Bit Image Write | 02h,44h,DAD,42h, aL,aH, sXL,sXH,sYL,sYH, d(1)...d(s) | Write bit image data to the specified area. DAD: Display address aL: Bit image write start address, lower byte aH: Bit image write start address, upper byte sXL: Bit image write size X, lower byte sXH: Bit image write size X, upper byte sYL: Bit image write size Y, lower byte sYH: Bit image write size Y, upper byte d(1)...d(s): Bit image data | p66 |
| Display start address | 02h,44h,DAD,53h, aL,aH | Set the Display start address. DAD: Display address aL: Display start address, lower byte aH: Display start address, upper byte | p67 |
| Display synchronous | 02h,44h,DAD,57h, 01h | Synchronizes the next command with internal display refresh cycle. | p67 |
| Brightness level | 02h,44h,DAD,58h, n | Set brightness level. DAD: Display address n: Brightness level setting n=00h: 0% n=01h: 25% n=02h: 50% n=03h: 75% n=04h: 100% n=10h: 0% n=11h: 12.5% n=12h: 25% n=13h: 37.5% n=14h: 50% n=15h: 62.5% n=16h: 75% n=17h: 87.5% n=18h: 100% | p67 |

5.4.1 Command Details

5.4.1.1 STX 44h DAD 46h aL aH sL sH d(1)...d(s) (Bit image write)

Code: 02h 44h DAD 46h aL aH sL sH d(1)...d(s)

DAD: Display address
aL: Bit image write address, lower byte
aH: Bit image write address, upper byte
sL: Bit image write size, lower byte
sH: Bit image write size, upper byte
d(1)–d(s): Bit image data

Definable area: $00h \leq DAD \leq FFh$
 $0000h \leq (aL + aH \times 100h) \leq Max_DispMemAddr$
 $0001h \leq (sL + sH \times 100h) \leq DispMemSize$
 $(aL + aH \times 100h) + (sL + sH \times 100h) \leq DispMemSize$
 $00h \leq d \leq FFh$

Function: Write bit image data to the specified address.

If the Write address or Write size are outside the definable area, the command (STX to sH) is cancelled, and the display waits for the next header (STX).

During Bit image write, data from the host is transferred to the Display Memory using DMA. This may result in a flickering display if a large volume of data is written at high speed. If display flickering occurs, ensure that data writing is in accordance with the timing requirements described in the hardware specification at “Parallel interface timing 2”.

Example for 256×64 dot module:

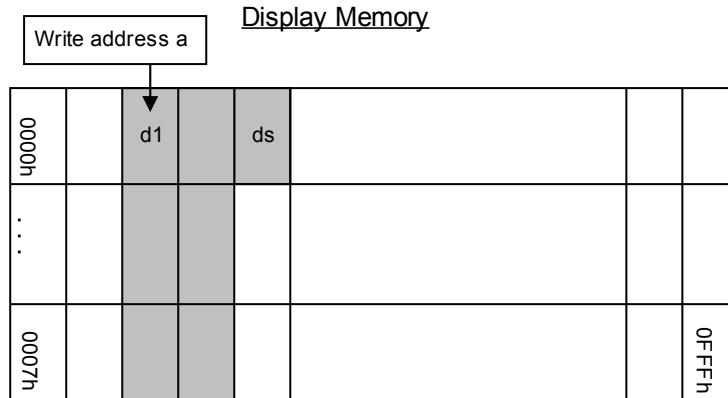

5.4.1.2 STX 44h DAD 42h aL aH sXL sXH sYL sYH d(1)...d(s) (BOX Area Bit image write)

Code: 02h 44h DAD 42h aL aH sXL sXH sYL sYH d(1)...d(s)

- DAD: Display address
- aL: Bit image write start address, lower byte
- aH: Bit image write start address, upper byte
- sXL: Bit image write size X, lower byte
- sXH: Bit image write size X, upper byte
- sYL: Bit image write size Y, lower byte
- sYH: Bit image write size Y, upper byte
- d(1)–d(s): Bit image data

Definable area: $00h \leq DAD \leq FFh$
 $0000h \leq (aL + aH \times 100h) \leq \text{Max_DispMemAddr}$
 $0001h \leq (sXL + sXH \times 100h) \leq \text{Xdots}$
 $0001h \leq (sYL + sYH \times 100h) \leq \text{Ybytes}$
 Note: X size and Y size must both be within the Display Memory area.
 $00h \leq d \leq FFh$

Function: Write bit image data to the specified area.

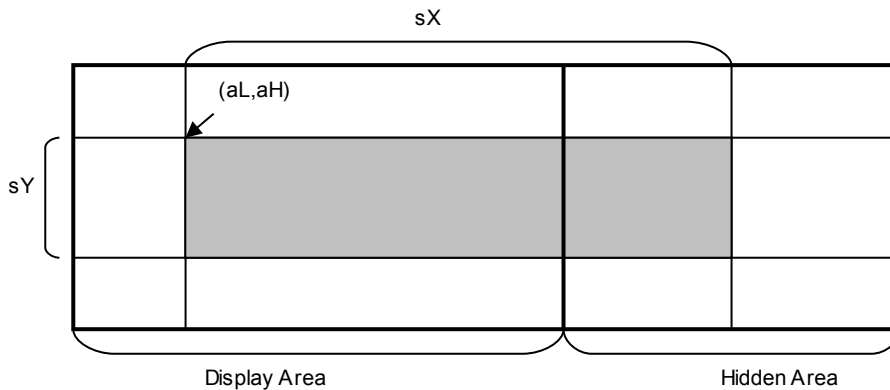

If the Write address or Write size are outside the definable area, the command (STX to sH) is cancelled, and the display waits for the next header (STX).

5.4.1.3 STX 44h DAD 53h aL aH (Display start address)

Code: 02h 44h DAD 53h aL aH

DAD: Display address
 aL: Display start address, lower byte
 aH: Display start address, upper byte

Definable area: $00h \leq DAD \leq FFh$
 $0000h \leq (aL + aH \times 100h) \leq \text{Max_DispMemAddr}$

Function: Set the Display start address (top left position of display screen).

Command is ignored if Display start address is outside the definable area.

Example for 256×64 dot module:

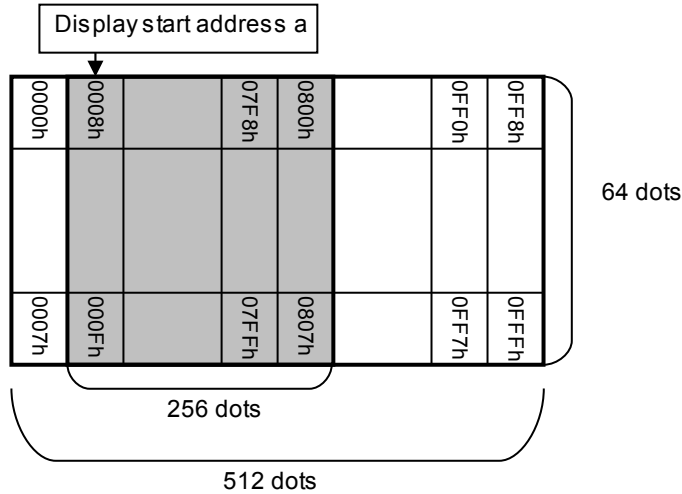

5.4.1.4 STX 44h DAD 57h 01h (Display synchronous)

Code: 02h 44h DAD 57h 01h

DAD: Display address

Definable area: $00h \leq DAD \leq FFh$

Function: Synchronizes the next command with internal display refresh cycle.

Smooth scroll display is possible by using this command in combination with "Display start address" command.

5.4.1.5 STX 44h DAD 58h n (Brightness level)

Code: 02h 44h DAD 58h n

DAD: Display address

n: Brightness level setting

Definable area: $00h \leq DAD \leq FFh$
 $00h \leq n \leq 04h, 10h \leq n \leq 18h$

Default: $n = 04h$ or Memory SW setting.

Function: Set brightness level, as shown below.

| n | Brightness level |
|-----|------------------|
| 00h | 0% |
| 01h | 25% |
| 02h | 50% |
| 03h | 75% |
| 04h | 100% |
| 10h | 0% |
| 11h | 12.5% |

| n | Brightness level |
|-----|------------------|
| 12h | 25% |
| 13h | 37.5% |
| 14h | 50% |
| 15h | 62.5% |
| 16h | 75% |
| 17h | 87.5% |
| 18h | 100% |

6 Setup

6.1 DIP-Switch (SW1)

| SW No. | Function | Default |
|--------|-------------------------------|---------|
| 1 | Display address select | Off |
| 2 | | Off |
| 3 | | Off |
| 4 | | Off |
| 5 | RS-232 communication settings | Off |
| 6 | Command mode select | Off |
| 7 | Operating Mode select | Off |
| 8 | Protocol select | Off |

6.1.1 Display address (for Packet mode and Graphic DMA mode)

Display address is set by a combination of DIP-SW and Memory SW.

| bit 7 | bit 6 | bit 5 | bit 4 | bit 3 | bit 2 | bit 1 | bit 0 |
|-------------|-------------|-------------|-------------|---------------|---------------|---------------|---------------|
| MSW50 bit 7 | MSW50 bit 6 | MSW50 bit 5 | MSW50 bit 4 | DIP-SW SW4 | DIP-SW SW3 | DIP-SW SW2 | DIP-SW SW1 |
| | | | | ON=1 OFF=0 | ON=1 OFF=0 | ON=1 OFF=0 | ON=1 OFF=0 |

If the above address is FFh, the setting is ignored and 00h is assumed.

6.1.2 RS-232 communication settings

Communication settings are set by a combination of DIP-SW and Memory SW.

| SW5 | Setting | | | |
|-----|--|--|--------|-----------|
| | Baud Rate | Parity | Data | Stop bits |
| OFF | 38400 bps | No parity | 8 bits | 1 bit |
| ON | MSW48 setting 00h: 19200 bps 01h: 4800 bps 02h: 9600 bps 03h: 19200 bps 04h: 38400 bps 05h: 57600 bps 06h: 115200 bps 07h: Prohibited* 08h: Prohibited* 09h: Prohibited* 0Ah: Prohibited* 0Bh: Prohibited* 0Ch-FFh: 19200 bps * Operation is not guaranteed, so do not use this setting. | MSW49 setting 00h: No parity 01h: Even parity 02h: Odd Parity 03h-FFh: No parity | 8 bits | 1 bit |

6.1.3 Command Mode

| SW6 | Mode | |
|-----|---------------------|---|
| OFF | Normal command mode | Character, Graphic display mode |
| ON | Graphic DMA mode | High speed graphic display mode (parallel only) |

6.1.4 Operating Mode

| SW7 | Mode | |
|-----|-----------------------|--|
| OFF | Normal operation mode | Normal display operating mode |
| ON | Memory re-write mode | Memory re-write mode for firmware, fonts, etc. |

6.1.5 Protocol mode

| SW8 | Mode | |
|-----|-------------|---|
| OFF | Direct mode | Module accepts all of data regardless of address setting. |
| ON | Packet mode | Only the display with address that matches packet address processes the data. If packet address is FFh, all displays process the data. |

6.2 Memory SW

| Switch No. | Function | Valid range | Default |
|------------|--|---------------------|---------|
| 0 | International font set | 00h–0Dh | 00h |
| 1 | Character table type | 00h–05h,10h–13h,FFh | 00h |
| 2 | Horizontal scroll speed | 00h–1Fh | 00h |
| 3 | Reverse display | 00h,01h | 00h |
| 4 | Write mixture display mode | 00h–03h | 00h |
| 5 | Brightness level setting | 00h–04h,10h–18h | 04h |
| 6 | Reserved | - | - |
| 7 | Write screen mode | 00h,01h | 00h |
| 8 | Font size | 01h,02h,03h,04h | 01h |
| 9 | 2-byte character | 00h,01h | 00h |
| 10 | Font magnification X | 01h–04h | 01h |
| 11 | Font magnification Y | 01h–04h | 01h |
| 12 | Bold character | 00h,01h | 00h |
| 13 | 2-byte character type | 00h–03h | 00h |
| 14 | Horizontal scroll display quality select | 00h,01h | 00h |
| 15 | Reserved | - | - |
| 16 | Download character restore at power-on (FROM→RAM) 6×8 dot (00h = Don't restore) | 00h,01h | 00h |
| 17 | Download character restore at power-on (FROM→RAM) 8×16 dot (00h = Don't restore) *1 | 00h,01h | 00h |
| 18 | Download character restore at power-on (FROM→RAM) 16×16 dot (00h = Don't restore) *2 | 00h,01h | 00h |
| 19 | FROM Macro execution at power-on (00h = Not execute) | 00h–04h,81h–84h | 00h |
| 20–47 | Reserved | - | - |
| 48 | RS-232 Baud rate setting | 00h–0Bh | 00h |
| 49 | RS-232 Parity setting | 00h–02h | 00h |
| 50 | Display address setting (lower 4 bits not used) | 0xh–Fxh | 00h |
| 51 | Packet mode response setting (00h = No response) | 00h,01h | 00h |
| 52 | Macro end code Enable/Disable | 00h,01h | 00h |
| 53 | Macro end code | 00h–FFh | 00h |
| 54 | Macro end Clear Screen setting | 00h,01h | 00h |
| 55–63 | Reserved | - | - |

Note: Module operates with default value if Memory SW value is outside the valid range.

* 1: If setting is 01h, download characters for 12×24 dot and 16×32 dot are also restored.

* 2: If setting is 01h, download characters for 32×32 dot are also restored.

Notice for the Cautious Handling of VFD Modules

Handling and Usage Precautions:

Please carefully follow the appropriate product application notes and operation standards for proper usage, safe handling, and maximum performance.

[VFD tubes are made of glass]

- The edges of the VFD glass envelope are not smooth, so it is necessary to handle carefully to avoid injuries to hands.
- Use caution to avoid breaking the VFD glass envelope, to prevent injury from sharp glass particles.
- The tip of the exhaust pipe is fragile so avoid shock from impact.
- It is recommended to allow sufficient open space surrounding the exhaust pipe to avoid possible damage.
- Please design the PCB for the VFD module within 0.3 mm warping tolerance to avoid any forces that may damage the display due to PCB distortion causing a breakdown of the electrical circuit leading to VFD failure.

[High voltage]

- Avoid touching conductive electrical parts, because the VFD module uses high voltage exceeding 30 – 100 volts.
- Even when electric power is turned off, it may take more than one minute for the electrical current to discharge.

[Cable connection]

- Do not unplug the power and/or data cables of VFD modules during operation, because unrecoverable damage may result.
- Sending input signals to the VFD module when not powered can cause I/O port damage.
- It is recommended to use a 30cm or shorter signal cable to prevent functional failures.

[Electrostatic charge]

- VFD modules need electrostatic-free packaging and protection from electrostatic charges during handling and usage.

[Structure]

- During operation, VFD and VFD modules generate heat. Please consider sufficient heat radiation dissipation using heat sink solutions.
- Preferably, use UL-grade materials or components in conjunction with VFD modules.
- Warp and twist movement causes stress and may break VFDs and VFD modules. Please adhere to allowances within 0.3mm at the point of attachment.

[Power]

- Apply regulated power to the VFD module within specified voltages to protect from failures.
- VFD modules may draw in-rush current exceeding twice the typical current at power-on, so a power supply with sufficient capacity and quick starting of the power regulator is recommended.
- VFD module needs a specified voltage at the point of connection. Please use an adequate power cable to avoid a decrease in voltage. As a safety measure, a fuse or other over-current protection is recommended.

[Operating consideration]

- Illuminating phosphor will decrease in brightness during extended operation. If a fixed pattern illuminates for an extended period (several hours), the phosphor efficiency will decrease compared to the non-operating phosphor, causing non-uniform brightness. Please consider programming the display patterns to use all phosphor segments evenly. Scrolling may be a consideration for a period of time to refresh the phosphor condition and improve even illumination of the pixels.
- A signal cable 30cm or less is recommended to avoid possible disturbances to the signal.

[Storage and operating environment]

- Please use VFD modules under the recommended specified environmental conditions. Salty, sulfuric and dusty environments may damage the VFD module even during storage.

[Disposal]

- VFD uses lead-containing materials (RoHS directive exempts these lead compounds in the glass for electronic devices). When discarding VFDs or VFD modules, please adhere to applicable laws and regulations.

[Other cautions]

- Although the VFD module is designed to be protected from electrical noise, please plan your circuitry to exclude as much noise as possible.
- Do not reconstruct or repair the VFD module without our authorization. We cannot assure the quality or reliability of unauthorized reconstructed VFD modules.

Notice:

- We do not authorize the use of any patents that may be inherent in these specifications.
- Neither whole nor partial copying of these specifications is permitted without our approval. If necessary, please ask for assistance from our sales consultant.
- This product is not designed for military, aerospace, medical or other life-critical applications. If you choose to use this product for these applications, please ask us for prior consultation or we cannot accept responsibility for problems that may occur.

Revision history

| Specification number | Date | Revision |
|----------------------|---------------|-----------------|
| DS-1600-0008-00 | Oct. 27, 2010 | Initial release |
| | | |
| | | |